



Grant Agreement N°: 952189

Topic: ICT-53-2020



SG BLUEPRINT

Next generation connectivity for enhanced, safe & efficient transport & logistics

D4.3: CACC enabled cars and containers use case

Final report

Revision: v.1.0

Work package	WP 4
Task	Task 4.9
Due date	30-11-2023
Submission date	11-12-2023
Deliverable lead	V-tron
Version	V 1.0

Abstract

The 5G-Blueprint project aims to enhance and create a guideline, exploiting 5G network for real-time precision control of vehicles and outline the possibilities for new use cases. This transformative approach addresses driver-related challenges and offers economic and environmental benefits in long-distance logistics.

This report, as a part of a broader work package, details two use cases: Teleoperation-based platooning and remote takeover operation, specifically focusing on remote takeover for cars. This report comprehensively evaluates the capabilities of teleoperated platooning, emphasizing seamless communication in diverse traffic conditions. The research extends to cross-border operations, exploring the adaptability of such a system in navigating diverse regulatory environments, highlighting the possibilities for international logistics and transportation.

The report further provides detailed insights into the successful implementation of the system, including necessary vehicle modifications and the relevant system architecture required to fulfill the defined objectives. Extensive testing was conducted to address the challenges encountered throughout the development process, and the resulting system was evaluated based on the predefined Key Performance Indicators (KPIs).

By presenting these findings, the project aims to contribute valuable knowledge to the field, offering practical applications for 5G technology in the field of vehicle control and transportation.

Keywords: 5G network, Teleoperation based platooning, Cross-border, Remote takeover, Seamless communication

Document Revision History

Version	Date	Description of change	List of contributor(s)
0.1	02-10-2023	TOC and document structure	Arun Naren, Rakshith Kusumakar
0.2	10-11-2023	First draft	Arun Naren
0.3	23-11-2023	Review and updates	Arun Naren, Rakshith Kusumakar
0.4	01-12-2023	Internal review by project partners	Stefan Yzewyn (NSP) Jos Korstanje (VER)
0.5	04-12-2023	Internal review feedback updated	Arun Naren, Rakshith Kusumakar
1.0	11-12-2023	Final version	Wim Vandenberghe (MIW)

Disclaimer

The information, documentation, and figures available in this deliverable, is written by the 5G-Blueprint (Next generation connectivity for enhanced, safe & efficient transport & logistics) – project consortium under EC grant agreement 952189 and does not necessarily reflect the views of the European Commission. The European Commission is not liable for any use that may be made of the information contained herein.

Copyright notice: © 2020 - 2023 5G-Blueprint Consortium

Project co-funded by the European Commission under H2020-ICT-2018-20		
Nature of the deliverable:		
Dissemination Level		
PU	Public, fully open, e.g., web	√
CI	Classified, information as referred to in Commission Decision 2001/844/EC	
CO	Confidential to 5G-Blueprint project and Commission Services	

* R: Document, report (excluding the periodic and final reports)

DEM: Demonstrator, pilot, prototype, plan designs

DEC: Websites, patents filing, press & media actions, videos, etc.

OTHER: Software, technical diagram, etc

EXECUTIVE SUMMARY

The 5G-Blueprint project represents a promising effort in the logistics sector, propelled by a commitment to redefine driving optimization through the integration of advanced 5G network technology. Targeting the specific challenges embedded in the transportation and logistics sector, this initiative introduces a transformative shift in overall operations. By facilitating the remote control of vehicles for assisting automated functionalities, the project aims to substantially reduce operational costs and enhance adaptability in an industry driven by technological innovation.

The project has defined four distinct use cases designed to assess and validate this operational optimization. In this specific use case, the focus is placed on vehicular applications, involving the use of an automated platooning system integrated with remote takeover functionalities. Furthermore, the use case expands its scope to cross-border operations, examining the feasibility and effectiveness of teleoperated platooning systems in managing diverse regulatory environments and infrastructure. This investigation underlines the potential implications for cross-border logistics and transportation in a global scale.

This report focuses on advancements made in the development of a Teleoperation-Based Platooning system, with a particular emphasis on the vehicle side. The approach comprised of three different phases, including, architecture design, hardware & software development, and testing & validation. The architecture involves a lead vehicle teleoperated and a following vehicle initially driven by a safety driver or teleoperator, with the ability for remote takeover. Significant hardware and software modifications are implemented in both the test vehicle and remote station, coupled with network integration, to facilitate control over the vehicles. The platooning operation relies on hybrid communication for real-time data exchange between vehicles and incorporates an Artificial Potential Function based controller to maintain the required distance to the vehicle in front. The system affiliates teleoperation and remote takeover capability, allowing the teleoperator to assume control of the vehicles, facilitated by low-latency, long-range 5G communication.

Furthermore, to assess and validate the advancements achieved during the development, three pilot locations have been determined. These locations serve as testing grounds to evaluate the developments based on predefined KPIs. Continuous testing was conducted to assess the robustness of the systems and to iteratively enhance their performance. The results derived from these comprehensive tests indicate the refinement of the developments. Notably, a 0.8-second headway time is attained for the platooning system, facilitating close following while ensuring safe operations. The teleoperation system demonstrates the effectiveness, with the input provided at the remote station closely mirroring the actual vehicle actuators, showcasing minimal errors and validating the feasibility of secure teleoperation.

Moreover, the evaluation of cross-border teleoperation proved successful, with an ultra-low handover latency of 120 milliseconds. This accomplishment underscores the system's capability to seamlessly transition control across borders. In summary, all objectives outlined in the use cases are successfully met, affirming the overall success of the developments.

TABLE OF CONTENTS

- EXECUTIVE SUMMARY4**
- TABLE OF CONTENTS.....5**
- LIST OF FIGURES7**
- LIST OF TABLES8**
- ABBREVIATIONS9**
- 1 USE CASE INTRODUCTION10**
 - 1.1 Teleoperation based platooning.....10
 - 1.2 UC objectives11
 - 1.3 State of the art12
 - 1.4 Report structure13
- 2 USE CASE ARCHITECTURE15**
 - 2.1 Software architecture15
 - 2.1.1 CACC system architecture15
 - 2.1.2 Teleoperation architecture15
 - 2.1.3 Functional architecture.....17
 - 2.2 Hardware architecture.....19
 - 2.2.1 Test vehicles.....19
 - 2.2.2 CACC hardware.....19
 - 2.2.3 Teleoperation hardware.....20
 - 2.2.4 Remote station22
- 3 USE CASE DEVELOPMENT.....23**
 - 3.1 CACC development23
 - 3.1.1 Controller modelling23
 - 3.1.2 Scaled prototype24
 - 3.1.3 Full scale development25
 - 3.2 Vehicle actuators for teleoperation development26
 - 3.2.1 Throttle controller26
 - 3.2.2 Brake controller27
 - 3.2.3 Steering controller.....27
 - 3.3 Remote station integration.....28
 - 3.3.1 Interfacing.....29
 - 3.3.2 Principle29
 - 3.4 Fail safe system30
 - 3.4.1 Platooning failure.....30
 - 3.4.2 Remote safety button30
 - 3.4.3 Remote station hardware failure.....30



- 3.4.4 VRU in danger.....30
- 3.4.5 Implementation.....31
- 3.4.6 Increased latency constraints31
- 3.5 Network integration.....32
- 4 TEST PLAN.....33**
- 4.1 Testing approach for platooning.....33
- 4.1.1 Preconditions - CACC33
- 4.1.2 Procedure - CACC33
- 4.2 Testing approach for teleoperation34
- 4.2.1 Preconditions - Teleoperation34
- 4.2.2 Procedure - Teleoperation34
- 4.3 Pilot location35
- 4.3.1 Vlissingen & Antwerp pilot site36
- 4.3.2 Zelzate cross border site.....38
- 4.4 KPI definition.....39
- 5 RESULTS & DISCUSSION.....40**
- 5.1 CACC test results.....40
- 5.1.1 Headway time:.....40
- 5.1.2 Distance error:40
- 5.1.3 Maximum speed achieved:40
- 5.1.4 Communication latency and packet loss:40
- 5.2 Teleoperation test results.....43
- 5.2.1 Steering accuracy43
- 5.2.2 Pedals accuracy.....43
- 5.2.3 Maximum safe speed.....43
- 5.3 Zelzate test results46
- 5.4 V2V vs V2N testing46
- 6 CONCLUSIONS49**
- APPENDIX A – PROCESS FLOW.....50**
- APPENDIX B – VEHICLE POV51**
- APPENDIX C – CACC BENCHMARKING52**
- REFERENCES54**



LIST OF FIGURES

- Figure 1 - UC visualization 11
- Figure 2 - Report structure 13
- Figure 3 - High level architecture for CACC system..... 15
- Figure 4 - Teleoperation architecture 16
- Figure 5 - Teleoperation protocol..... 16
- Figure 6: Message sequence diagram..... 17
- Figure 7 - Pilot vehicles 19
- Figure 8 - CACC hardware 19
- Figure 9 - Teleoperation hardware 20
- Figure 10 - Teleoperation cameras 21
- Figure 11 - Pilot vehicle with teleoperation cameras installed..... 22
- Figure 12 - Remote station setup..... 22
- Figure 13 - CACC functionality..... 23
- Figure 14 - Control strategy 24
- Figure 15 - Scaled prototype architecture 24
- Figure 16 - Scaled vehicle used for UC development..... 25
- Figure 17 - Longitudinal controller 26
- Figure 18 - Brake actuator..... 27
- Figure 19 - Steering controller 27
- Figure 20 - Control loop 28
- Figure 21 - DBW box..... 28
- Figure 22 - DBW interfacing 29
- Figure 23 - Safety stop implementation 31
- Figure 24 - Overall storyline 36
- Figure 25: Vlissingen site route 37
- Figure 26 - Antwerp site route 37
- Figure 27 - Picture taken in Zelzate site 38
- Figure 28: Zelzate cross-border site route..... 38
- Figure 29 – CACC test results 41
- Figure 30 - V2V latency plot 41
- Figure 31 - Antwerp test results 44
- Figure 32 - Vlissingen test results 44
- Figure 33 - V2V results 47
- Figure 34 - V2N results 48



LIST OF TABLES

Table 1: Signal description..... 18

Table 2: Router specification..... 21

Table 3: Camera specifications 21

Table 4: Pilot activities 36

Table 5: KPI measurement methodology 39

Table 6: Modifications in KPIs 39

Table 7: CACC KPIs measured in Vlissingen pilot site..... 42

Table 8: CACC KPIs Statistical values 42

Table 9: Teleoperation KPIs..... 45

Table 10: Teleoperation KPIs Statistical values 45

Table 11: Comparison between V2V and V2N results 47



ABBREVIATIONS

5G SA	5G Stand-Alone network
5G NSA	5G Non-Stand-Alone network
ACC	Adaptive Cruise Control
ADC	Analog to digital converter
APF	Artificial potential field
CACC	Co-operative Adaptive Cruise Control
CAN	Controller Area Network
CGW	Central GateWay
C-V2X	Cellular Vehicle to Everything
DAC	Digital to analog converter
DWB	Drive by wire
ECM	Engine Control Module
ECU	Electronic Control Unit
GPS	Global positioning system
KPIs	Key Performance Indicators
LTE	Long term evolution
MCU	Micro controller unit
MNO	Mobile Network Operator
OBU	On-Board Unit
OEM	Original Equipment Manufacturer
POV	Point of View
QoS	Quality of service
RADAR	Radio detection and ranging
RDWB	Roboauto drive by wire
TCP	Transmission control protocol
TO	Teleoperator
TOC	Teleoperation Center
UC	Use Case
UDP	User datagram protocol
V2N	Vehicle to Network
V2V	Vehicle to Vehicle
VRU	Vulnerable road user

1 USE CASE INTRODUCTION

The 5G-Blueprint project, funded by the European Union through Horizon 2020, is a cross-border collaborative project between the Netherlands and Belgium. With a focus on utilizing 5G network technology, this project aims to create, develop, and establish a benchmark for the future developments within the transportation and logistics industries.

Within the project, there are four use cases defined. This report concentrates specifically on UC 4.3 Teleoperation-based Platooning, and UC 4.4, Remote Takeover application. UC 4.4 serves as a generic use case intended to complement all other use cases within the work package. The report addresses the implementation of teleoperation-based platooning with the remote takeover application for cars.

1.1 Teleoperation based platooning

The ongoing trend of more vehicles on the road and increased human mobility has resulted in higher traffic volumes and a greater demand for highway travel. This growth in traffic has led to increased congestion, further emphasizing the necessity for improved traffic flow and highway optimization. Within the logistics sector, the concept of platooning has emerged as a prominent strategy. Platooning involves the synchronization of two or more vehicles in close formation along dedicated highway stretches. This coordination is made possible through a fusion of technologies, including adaptive cruise control, lane-keeping systems, and vehicle-to-vehicle (V2V) communication. Numerous studies have conclusively established the economic and environmental benefits of platooning, primarily driven by the reduction in aerodynamic drag. These benefits include decreased fuel consumption and lower emissions.

Despite the promise of platooning, most stakeholders struggle to identify a viable business case. The cost-saving potential of platooning remains constrained, given that the driver's role represented the most substantial operational expense. This challenge compounded with an ongoing issue within the trucking sector where there is a severe shortage of skilled drivers. Within the scope of the 5G-Blueprint project, the mission is to enhance this existing technology by leveraging the capabilities of 5G network connectivity and to demonstrate a compelling business proposition. The anticipated outcome of this approach is a significant reduction in operational costs.

The incorporation of 5G technology provides us with the capability to shift the driver from the vehicle to a remote station. This allows partial automation of the operation, offering the flexibility for either an onboard driver or a teleoperator to control the lead vehicle while concurrently enabling full automation for the following vehicle(s). The teleoperator can take control of the vehicles (remote takeover) at any time based on the dynamic operational conditions. Remote takeover is a process in which a remote operator assumes control of a vehicle located at a distance. The vehicles are configured to be operable remotely, from a remote station. To enable this remote operation, the vehicles are equipped with onboard communication units and integrated cameras that are crucial in delivering teleoperation functionality.

The concept of teleoperation within transportation and logistics industry is a transformative approach. It capitalizes on the capabilities of long-range communication, enabled by robust 5G networks, which allows to exert precise and real-time control over vehicles. Furthermore, the cross-border aspect of employing teleoperation and platooning is a novel approach in the context of international transportation and logistics. Long-range communication, enabled by 5G networks, transcends geographical boundaries, allowing teleoperators to seamlessly control vehicles as they cross international highways. Simultaneously, hybrid communication enabled by Cellular Vehicle to Everything (C-V2X), typically used for platooning, ensures the close coordination and synchronization of vehicles within the platoon.

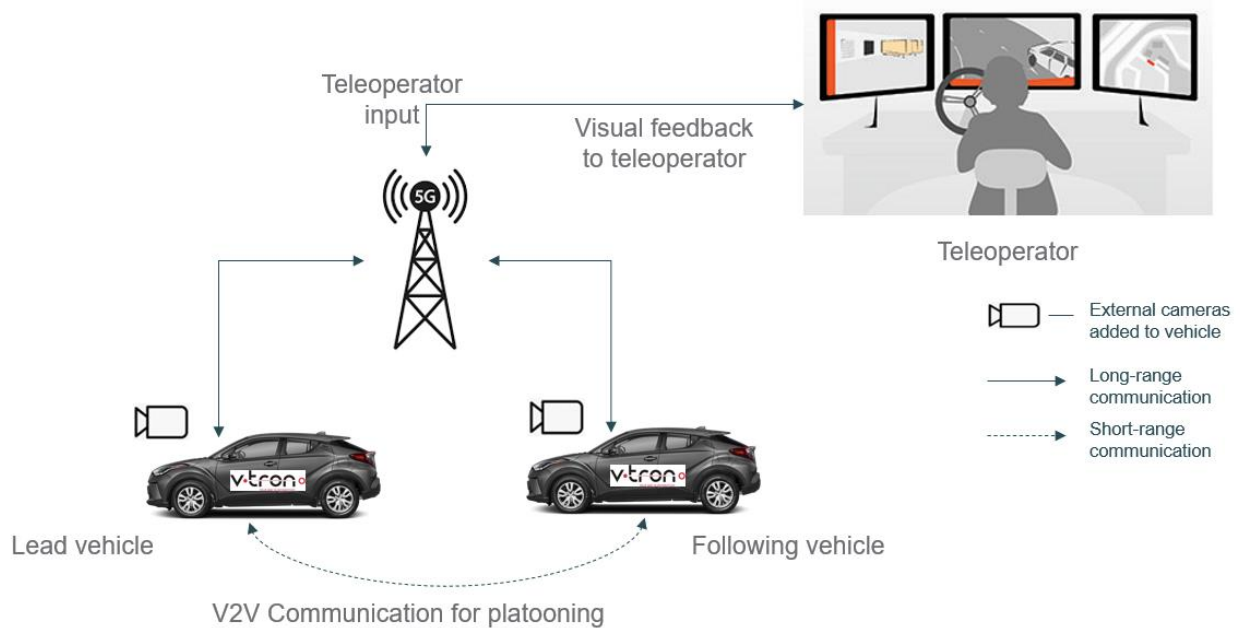

Figure 1 - UC visualization

Figure 1 provides an overview of the entire operational scenario outlined in this use case. The proof of concept is demonstrated using two Toyota test vehicles, specifically modified to showcase the planned activity. A dedicated remote station is established, equipped with the required hardware and software, enabling remote operators to seamlessly connect and take control of the vehicles. The vehicles are modified in order to be controlled remotely through the 5G network and Co-operative Adaptive Cruise Control (CACC) technology is used for platooning of vehicles. The detailed description of system architecture, both in terms of hardware and software, is presented in the subsequent chapters. Additionally, the overview of the use case process flow is presented in Appendix A.

1.2 UC objectives

The objective of this use case is to comprehensively assess and showcase the capabilities 5G network technology within the context of teleoperated platooning. This innovative experiment places a strong emphasis on the potential of 5G network communication to facilitate seamless communication to vehicles. The primary aim is to evaluate the performance of seamless teleoperation of the vehicles and CACC based platooning in real-world scenarios, encompassing diverse traffic conditions and variable speeds, all while accommodating communication delays, failures, and sensor latency.

The integration of hybrid C-V2X communication is pivotal for ensuring that both vehicles can maintain harmonious and responsive platoon. This use case explores the integration of teleoperation features, wherein the vehicles can be accessed via a resilient 5G network connection.

In addition to these objectives, this use case also extends its scope to cross-border operations, aiming to explore the practicality and effectiveness of teleoperated platooning systems when navigating through different regulatory environments and infrastructure. This expansion underscores the versatility and adaptability of these technologies on an international scale, potentially revolutionizing cross-border logistics and transportation.

1.3 State of the art

- Cooperative Adaptive Cruise Control:
 - The system utilizes CACC technology for platooning, which is an evolution of traditional Adaptive Cruise Control (ACC). CACC enables vehicles to communicate with each other to maintain a safe following distance.
 - By continuously exchanging data, vehicles in the platoon adjust their speed and spacing dynamically, optimizing traffic flow and enhancing safety.
 - Short-range C-V2X communication is integrated in the system, allowing vehicles to communicate with each other with low latency and reduced packet losses.
 - The presence of C-V2X can be extended in the future to enhance situational awareness by communicating with the infrastructure, and other road users.
- 5G Network Connectivity:
 - The overall system is empowered by 5G network capabilities, ensuring high-speed and low-latency communication between vehicles and remote-control centres.
 - This high-speed connectivity enables seamless remote takeover, even in complex and dynamic traffic scenarios.
- Teleoperation of cars:
 - The system integrates teleoperation capabilities for vehicles navigating public roads.
 - Remote operators can assume precise control in real-time, extending the technology's application beyond dedicated highway stretches.
 - Teleoperation maintains a human-in-the-loop approach, allowing remote operators to intervene in response to unpredictable situations on public roads.
 - This ensures a balance between automation and human oversight, enhancing safety in dynamic environments and thus social and legal acceptance.
- Remote Takeover:
 - The system allows for remote intervention in case of emergencies or situations requiring human control. Remote takeover is facilitated through a secure and reliable 5G connection.
 - Remote operators can take over the vehicle, ensuring a human-in-the-loop approach to handle complex and unpredictable situations.
- Seamless Cross-Border Operation:
 - One of the remarkable features of this use case is its ability to seamlessly operate across borders.
 - The major challenge in cross-border teleoperation is the need for seamless network switching as vehicles drive from one country's network to another. This section explores the technologies that facilitate smooth network handovers, ensuring uninterrupted communication between the vehicles and the remote station.
 - International cooperation, regulatory and standardized communication protocols ensure that platoons can cross national boundaries without disruptions, enhancing freight transportation efficiency.

The use case explores the potential of cross-border teleoperation and automation of vehicles, leveraging advanced 5G networks. It also emphasizes the critical role of 5G technology in enabling real-time communication within the automotive and logistics industry. The use case serves as a platform for ongoing research and development, offering the potential for continuous improvement and adaptation to evolving transportation needs. The findings provide a roadmap for the successful implementation of these technologies, ultimately reshaping the future of international transportation systems.

1.4 Report structure

The report is structured into several chapters as illustrated in Figure 2, each dedicated to a specific aspect of the use case.

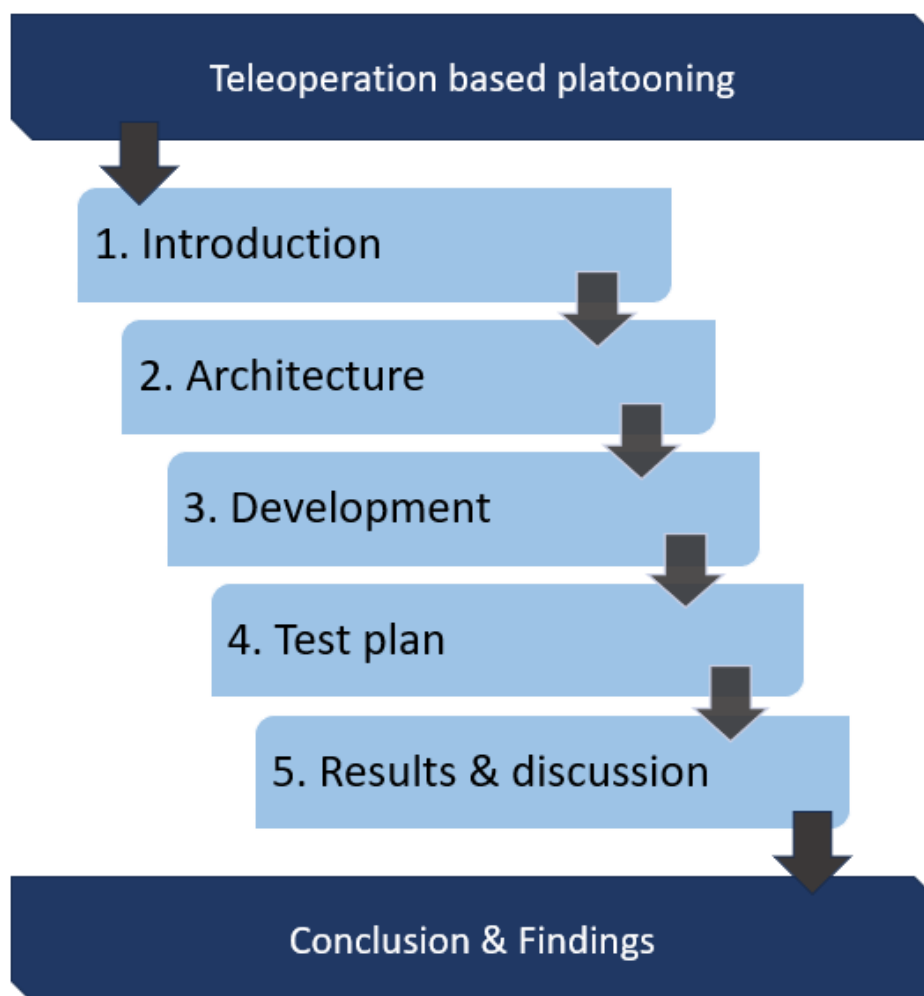

Figure 2 - Report structure

- **Chapter 1:** Introduces the core concept of the use case, highlighting the fusion of teleoperation and platooning and outlines the specific objectives that the use case aims to achieve.
- **Chapter 2:** Details the hardware and software components with their integration, focusing on the functional architecture. It also explores the hardware setup, including the test vehicles and the remote station.

- **Chapter 3:** Details the development phases of the use case.
 - Modelling: Discusses the initial modelling phase.
 - Scaled prototype: Describes the development of a scaled prototype.
 - Full-scale development: Explores the transition to full-scale development.
 - Teleoperation integration: Highlights the incorporation of teleoperation technology.
- **Chapter 4:** Outlines the testing procedures, including preconditions and the testing process with the pilot site description. This section also outlines the key performance indicators (KPIs) defined for the use case.
- **Chapter 5:** Test results discussion: Analyses the results of tests conducted at the pilot sites and evaluates with the predefined KPIs.
- **Chapter 6:** Summarizes the findings and conclusions drawn from the use case exploration.

2 USE CASE ARCHITECTURE

2.1 Software architecture

In the Teleoperation-Based Platooning system, the lead vehicle is teleoperated by a teleoperator, while the following vehicle, initially driven by a human driver or a teleoperator. CACC mode will be engaged when entering a constant speed zone. This CACC operation is enabled by PC5-based C-V2X communication, allowing real-time data exchange between vehicles. Crucially, the system incorporates a remote takeover capability, ensuring that the teleoperator can take control of the following vehicle during CACC operation if necessary. Upon leaving the constant speed zone, control returns to the driver, ensuring both safety and efficiency in the platooning scenario.

2.1.1 CACC system architecture

The schematic high-level architecture of the CACC system is given in Figure 3. The acceleration (a_{lead}) and velocity (v_{lead}) of the lead vehicle is obtained from the ECU and is sent to the On-Board Unit (OBU) through the On-board computer. The OBU then communicates this data to the following vehicle through V2V communication. The OBU of the following vehicle receives the communicated data and transfers it to the controller. The controller along with the other data inputs from vehicle RADAR (distance to the vehicle in front - D_{actual}) and vision system (headway time - H), computes the required acceleration to closely follow the lead vehicle. The vehicle states are obtained from the vehicle ECU and the CAN messages are decoded and translated to real values.

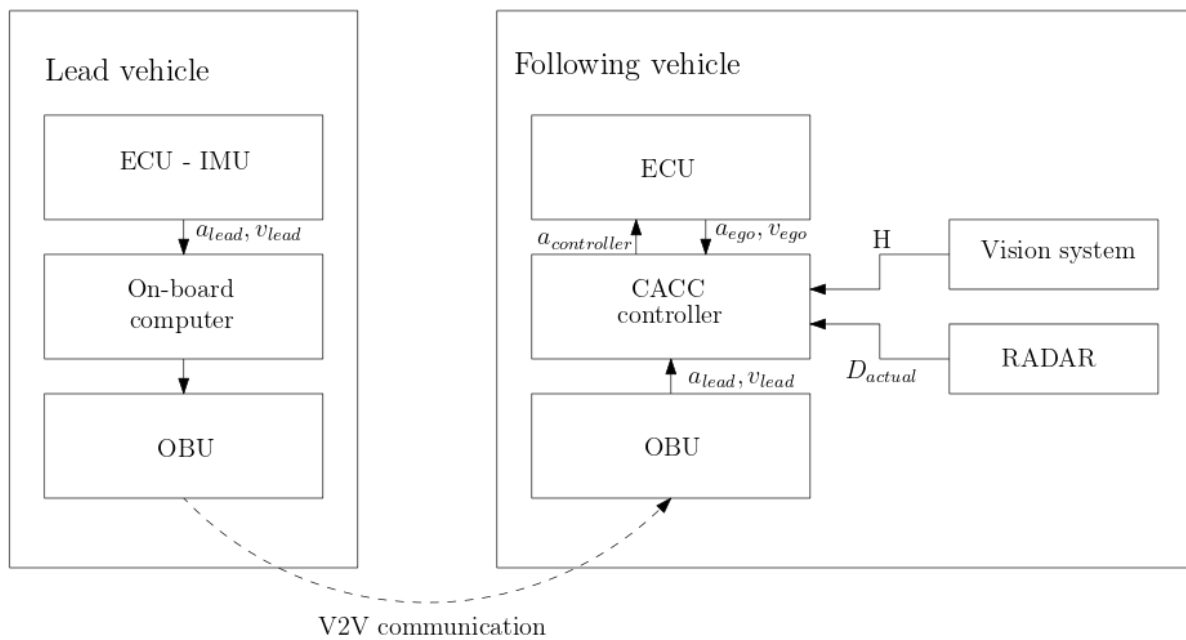

Figure 3 - High level architecture for CACC system

2.1.2 Teleoperation architecture

The heart of the teleoperation system is called the Gateway. The vehicles and remote stations connect to the Gateway where the vehicle or the remote station is authenticated. Once they are authenticated, they report their status to the gateway, which in turn sends the data to fleet management where it is visualized. Then, the teleoperator chooses to connect a vehicle and a remote station using fleet management. Once connected, the teleoperator is able to see the video streamed from the vehicle, as well as its speed and other data. The teleoperator may then choose

to take over the vehicle and drive it remotely to its desired location. Upon reaching the destination, they can release the vehicle and switch to driving another one. The high-level architecture for teleoperation is illustrated in Figure 4.

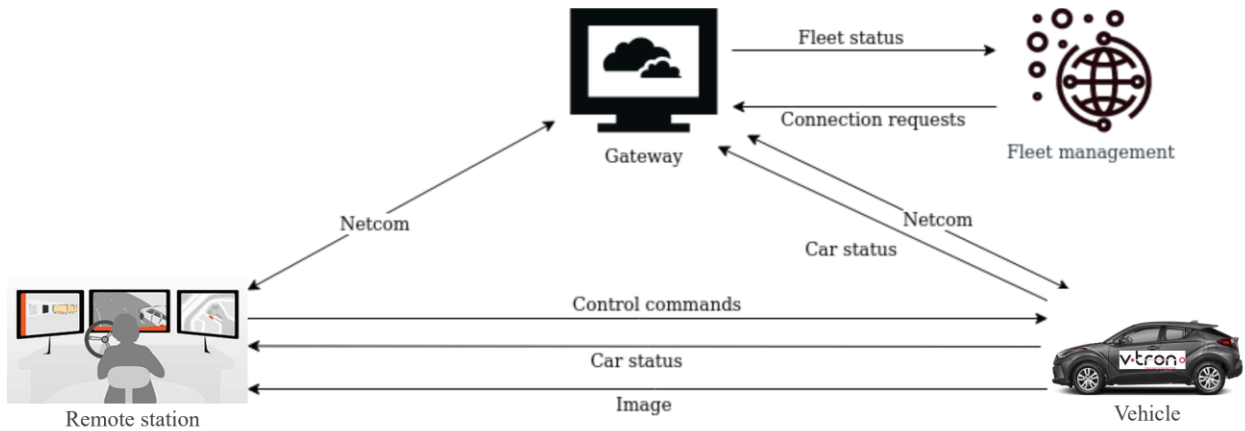

Figure 4 - Teleoperation architecture

Because the On-Board-Unit that is used for communication with the remote station is not connected to the vehicle interface itself and uses an interface to the Roboauto Drive-By-Wire (RDBW) to send commands instead, it can be placed into any vehicle with any interface. On the other side of this vehicle-agnostic interface is the V-tron DBW that runs a vehicle-specific program that translates the protocol to the vehicle's commands and sends them to the vehicle's interface (CAN communication protocol).

To increase the safety and reliability of the system, a redundant connection using multiple LTE carriers with independent networks is employed as shown in Figure 5. Thus, in the case of a temporary signal loss of one carrier, the control commands are still transmitted to the vehicle and the image stream and vehicle data are still being sent to the remote station. Because multiple routers are used, there is also hardware redundancy for the case when one of the routers fails.

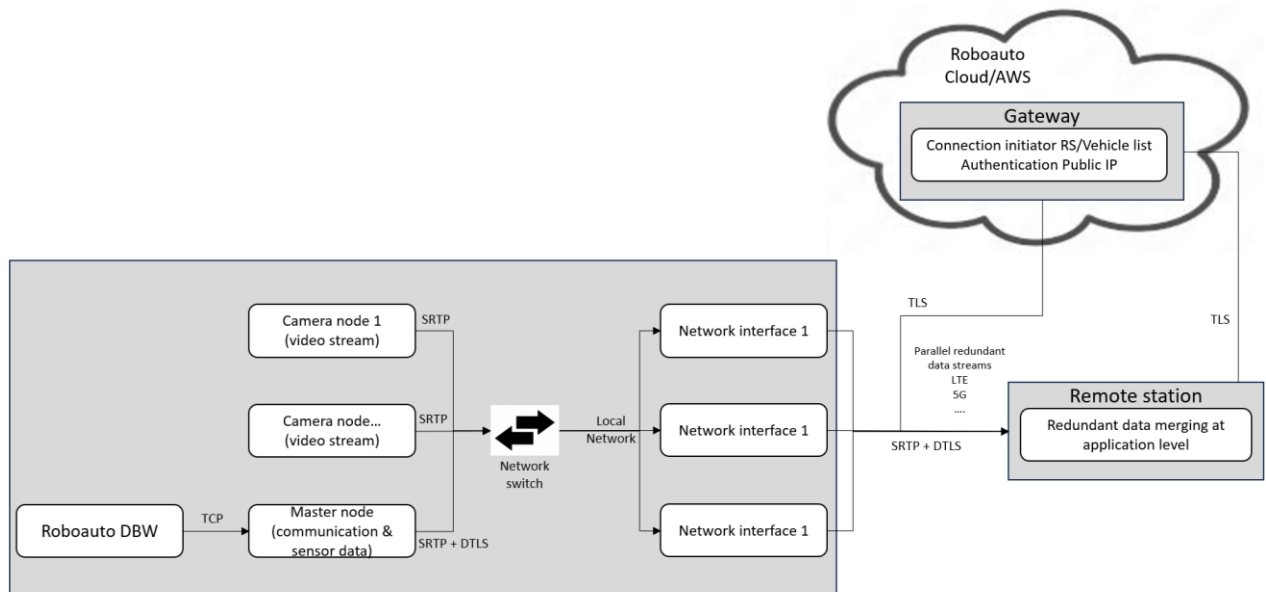

Figure 5 - Teleoperation protocol

2.1.3 Functional architecture

The Message Sequence Diagram in Figure 6 provides a visual representation that illustrates the flow of messages, interactions between remote station and vehicles, and the nature of the communication. Table 1 provides the description of these messages and their communication protocol.

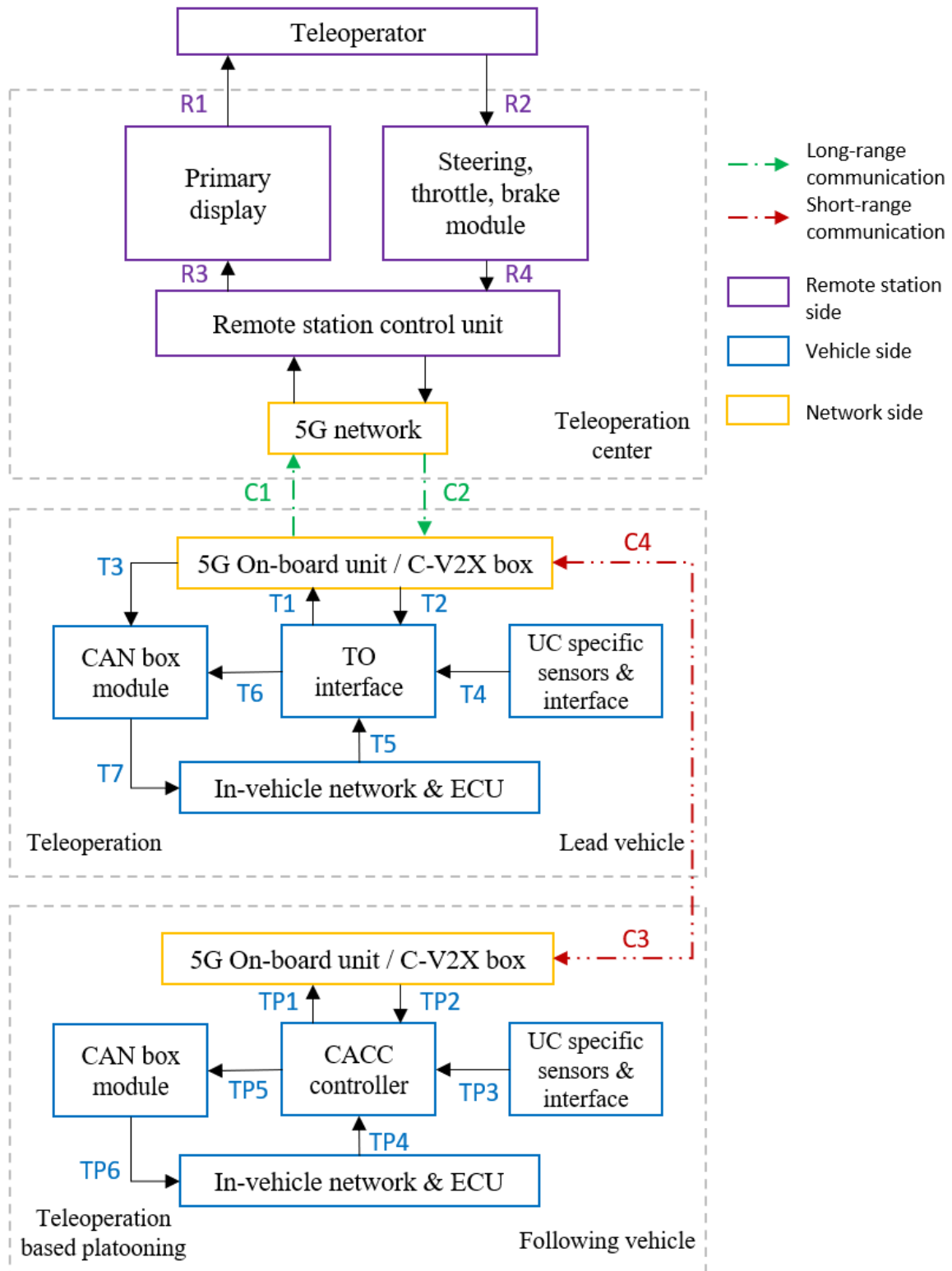

Figure 6: Message sequence diagram

Connection	Signals	Units	Protocol
R1	Vehicle POV to teleoperator	-	-
R2	Steering & throttle physical input	-	-
R3	Camera stream	-	-
R4	Control signals to vehicle	-	-
C1	Video feeds & vehicle feedback to remote station	-	5G
C2	Control signals from remote station	-	5G
C3	Lead vehicle data to following vehicle	-	PC5
C4	Status information to lead vehicle	-	PC5
T1	Video streams & vehicle feedback from vehicle	-	UDP
T2	Control data to interface	[deg/%]	UDP
T3	Camera stream	-	UDP
T4	Vehicle feedback data	[deg/%]	CAN
T5	Control data to vehicle	[deg/%]	CAN
T6	Steering inputs to vehicle actuator	[deg]	CAN
	Pedal inputs to vehicle actuator	[%]	
TP1	Feedback status	-	UDP
TP2	Lead vehicle data received by OBU and sent to controller	-	UDP
TP3	Following vehicle (in-vehicle) sensor data [headway time]	s	CAN
	Following vehicle (in-vehicle) RADAR data [actual distance to lead vehicle]	m	
TP4	Following vehicle acceleration [from ECU]	m/s ²	CAN
	Following vehicle velocity [from ECU]	m/s	
TP5	Controller output (Computed value - Desired acceleration)	m/s ²	-
TP6	Acceleration request to following vehicle (CAN message conversion)	m/s ²	CAN

Table 1: Signal description

2.2 Hardware architecture

2.2.1 Test vehicles

Two Toyota test vehicles, shown in Figure 7, are used to demonstrate the developments made in this use case. The most critical feature is that these vehicles support Drive-by-wire and Steer-by-wire functionalities, which is essential for controlling the longitudinal and lateral motion. These are hybrid electric vehicles equipped with Toyota safety sense which are a set of driver-assist and safety package as trademarked by Toyota. The vehicles come with radar, Ultrasonic and camera as a standard package which are used to aid the developed systems.¹



Figure 7 - Pilot vehicles

2.2.2 CACC hardware

The in-vehicle hardware setup, shown in Figure 8, is designed to facilitate communication and control within the vehicle, incorporating on-board computers and a C-V2X box for V2V communication.

- On-board computer:** The On-board computer plays a crucial role in managing in-vehicle communication and computing the required acceleration of the vehicle. It is responsible for processing and interpreting data received from various sources, including sensors, OBU, and the vehicle's Electronic Control Unit.
- C-V2X Box:** A crucial addition to the hardware setup is the Cellular Vehicle-to-Everything box, serving as the OBU for V2V communication. This component is dedicated to enabling communication between vehicles and transmitting essential data to/from the lead vehicle.



Figure 8 - CACC hardware

¹ These systems are employed based on their availability in the test vehicle and are not obligatory for the intended use case. However, their presence should be taken into account when modeling the system, as they are directly associated with safety architecture and in-vehicle communication priority.

2.2.3 Teleoperation hardware

The teleoperation hardware setup, shown in Figure 9, is designed to enable remote control of a vehicle, incorporating a combination of components for seamless communication and control. The system comprises a teleoperation box with on-board computers, 5G routers with antennas for long-range communication, DBW components for interfacing with the remote station, and cameras for providing visual feedback to the teleoperator.

- **On-Board Computers:** The teleoperation box is equipped with on-board computers. These computers act as the central processing units for interfacing with the vehicle's systems, also where the cameras are connected, enabling the teleoperator to remotely control and monitor the vehicle. The on-board computers facilitate a bidirectional communication for sending control commands from the teleoperator and receiving real-time data from the vehicle for feedback.
- **5G Routers:** The teleoperation setup is enhanced with 5G routers equipped with antennas, providing connectivity for communication with the remote station. The Sierra airlink 5G routers ensure robust and reliable long-range communication, enabling the teleoperator to control the vehicle from a remote location with minimal delay. The specification of the router is presented in Table 2.
- **DBW for Remote Station Interface:** DBW components are integrated into the hardware setup to establish a seamless interface with the remote station. These components mediate the exchange of data between the teleoperation system and the remote station.
- **Cameras for Visual Feedback:** The cameras are strategically placed on the vehicle to provide the teleoperator with real-time visual information with minimal blind spots.



Figure 9 - Teleoperation hardware

Features	Specs
Cellular radio	Single / Dual 5G
Peak downlink	4.14 Gbps
Peak uplink	660 Mbps
5G bands	NSA / SA support
Operating system	AirLink OS

Table 2: Router specification²

The MDC3 Camera, shown in Figure 10, is used as the teleoperation cameras to provide the visual feedback to the remote station. The camera adjusts image parameters to accommodate varying light intensities. With a low-light sensitivity of 1 millilux, the integrated high-performance imager ensures optimal visibility even in low-light settings. Additionally, it has anti-ice and anti-fog functions with a dedicated lens heater, making it suitable for our usecase.

The specification of the camera is given in Table 3.

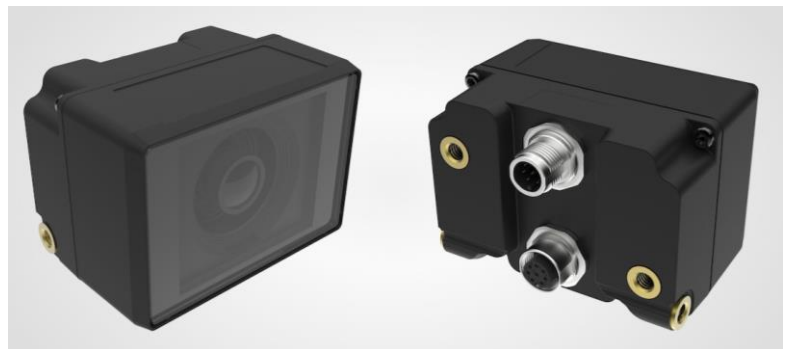

Figure 10 - Teleoperation cameras

Description	Values
Resolution	1280 x 960 pixels
Latency	< 75 ms
Frame rate	Max 40 fps
Protection class	IP67, IP6K9K (ISO 20653)

Table 3: Camera specifications

Test vehicle with cameras equipped is shown in Figure 11. The camera streams from the vehicle are attached in the Appendix A.

² Detailed specification of the router can be found here: <https://www.sierrawireless.com/router-solutions/xr90/#specs>.



Figure 11 - Pilot vehicle with teleoperation cameras installed

2.2.4 Remote station

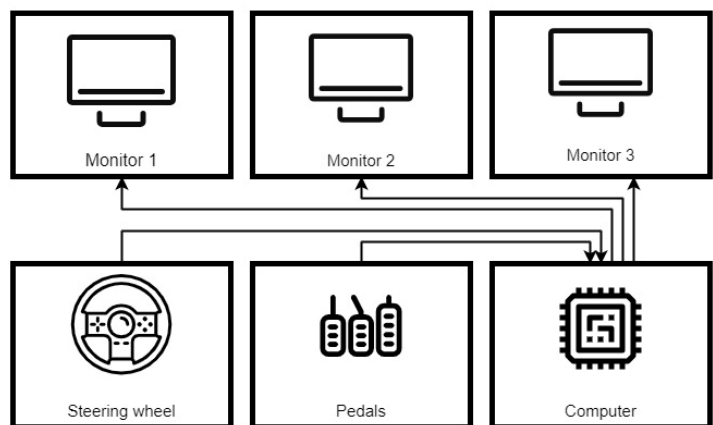

Figure 12 - Remote station setup

The remote station, shown in Figure 12, is designed to provide an efficient interface for teleoperators. Comprising three high-resolution monitors, the setup offers a detailed view of the vehicle's surroundings from real-time camera feeds. The monitors also display the vehicle feedback data, including speed, the live network status, ensuring a stable and reliable connection. The remote operation software is installed on the CPU, which is powerful to manage the heavy data streams between the remote station and the vehicle. Steering wheel and pedals are integrated in the setup to provide an intuitive control interface for operators. Wired to a 5G network, the remote station ensures high-speed, low-latency communication for responsive vehicle control.

3 USE CASE DEVELOPMENT

3.1 CACC development

CACC is an extension of Adaptive Cruise Control (ACC) in which data from the lead vehicle is sent to the ego vehicle to facilitate a smaller inter-vehicular distance. A schematic of the functionality of CACC is shown in Figure 13. It is seen that the ego vehicle follows the lead vehicle making use of the on-board sensors and the V2V communication. Considering two vehicles, a lead vehicle and an ego vehicle, the control objective is to make the ego vehicle achieve a desired distance to the lead vehicle. This desired distance varies according to the speed at which the vehicles are driven.

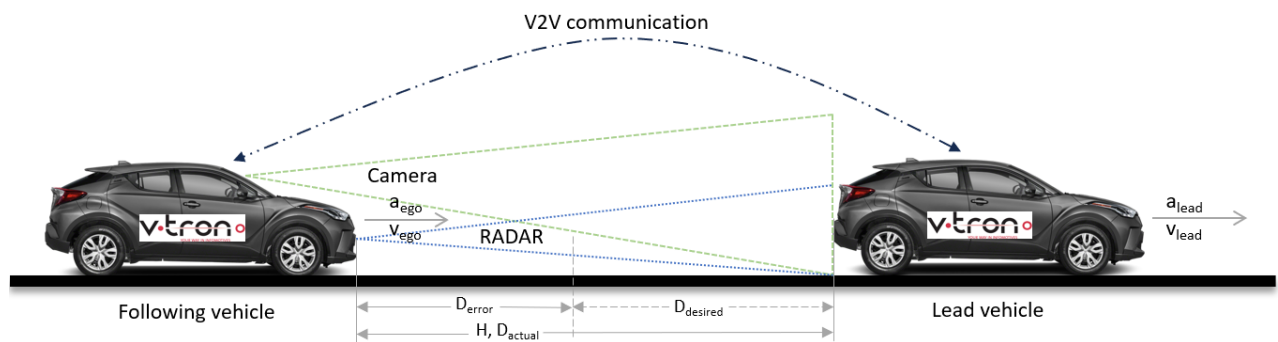

Figure 13 - CACC functionality

3.1.1 Controller modelling

Input needed for the CACC controller are, distance to the vehicle in front, desired distance, velocity of the ego vehicle which are obtained from the on-board sensors. The lead vehicle acceleration is obtained from on-board sensors and communicated using V2V through OBU.

Due to the non-linear characteristics of the CACC operation, different controller models were researched during this phase of the project. A few criteria were predefined which are crucial for the project, based on which the controller selection process was carried out.

- Reaction time of the controller must be faster (Reaction time of ACC is roughly 300 ms, for the CACC system, it should be around 100ms)
- The developed controller must be implementable in the on-board computer
- The controller must be able to achieve reduced headway time safely. (Typically, ACC systems have 1.2 second headway time, target with CACC is set at 0.8 second)

An APF (Artificial Potential Field) controller strategy, as shown in Figure 14, is used in the system to maintain the vehicle at the desired distance. The acceleration or deceleration required to maintain this desired distance is computed by this controller and is injected into the vehicle. The controller uses both feedforward and feedback loop to compute this acceleration. The lead vehicle acceleration is used for the feedforward control and the distance and velocity error is used for the feedback control. The aim of the CACC system is to control the platooning vehicle's longitudinal motion by means of an external controller added to the vehicle. The abovementioned controller should communicate with the vehicle to execute the specific control of acceleration and deceleration.

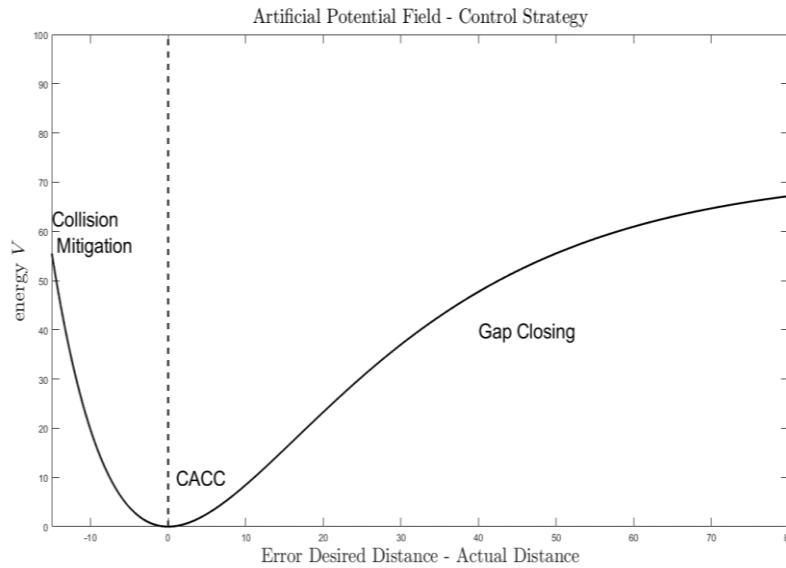

Figure 14 - Control strategy

3.1.2 Scaled prototype

To reduce the experimental time and for safer operation, the developed model was initially implemented in a scaled vehicle platform. To make the overall process more efficient, all the parameters such as V2V communication, in vehicle communication, on-board computers were kept similar to that of the real vehicle. This allowed us to analyze the performance of the controller in the physical environment and provided safer opportunities to test different scenarios. The architecture of the scaled prototype is shown in Figure 15.

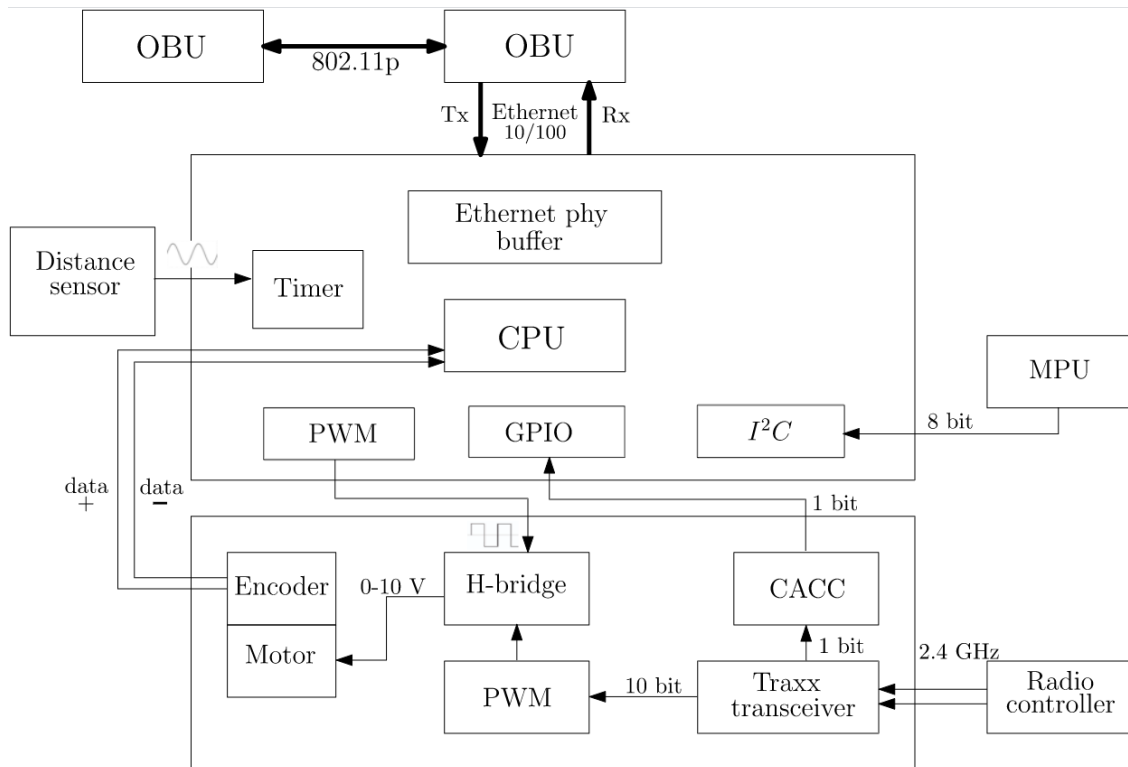

Figure 15 - Scaled prototype architecture

The scaled vehicles set-up, consists of two scaled (1:10 scale) Traxxas TRX-4 Land Rover Defender, shown in Figure 16, with an Olimex STM32E407 and the V-Tron's OBU (on-board unit) embedded on each Rover to process, receive and transmit data using the IEEE 802.11p standard (Wi-Fi-p) at maximum distance of 100m and a latency of 34ms in average. The OBU is connected to Olimex by ethernet which sends messages over UDP at 20Hz every time an event occurs, and the data is processed by the CPU. Moreover, the data from the environment is collected by several sensors such as the HC-SR04 for distance, which uses the time-of-flight of an ultrasonic pulse to count the time of the sound going and coming. An encoder sensor for measuring the speed of the



Figure 16 - Scaled vehicle used for UC development

rovers, which is connected directly to shaft of the motor counting RPMs and adjusted to the gearing ratio to calculate the actual speed. Finally, the MPU-6050 gyroscope is used to measure the vehicle acceleration with 6 degrees of freedom.

The tested scenario consists in driving the two rovers (one following the other) in straight line at the maximum speed which is 10km/h and measure the minimum distance that the following rover can maintain when the followed rover hard brake suddenly. First, in this scenario, the minimum distance is measured just using an ACC implementation and then the CACC is added to measure how much distance can be minimized.

3.1.3 Full scale development

3.1.3.1 Vehicle actuators for CACC

The aim of the CACC system is to control the platooning vehicle's longitudinal motion by means of an external controller added to the vehicle. The abovementioned controller should be able to communicate with the vehicle in order to execute the specific control of acceleration and deceleration. The primary approach would be to inject vehicle specific messages into the communication network as a way of manipulating its motion. This enables to perform the specific control without altering the production vehicle hardware by a large degree. Through this approach, the desired control can be achieved and restore full control to the driver if the pedals are pressed.

3.1.3.2 Stock ACC manipulation

The factory ACC system of the Toyota C-HR is controlled fully by the millimeter wave Radar. The sensor unit transmits control commands to the vehicle, with the most significant and relevant ones being acceleration request, vehicle detection flag and whether the vehicle can use the brakes when in ACC operational mode. The actual control over the brakes and engine output is executed by the Brake ECU and Engine Control Module (ECM) ECU. The vehicle CAN structure is branched into 5 separate buses which are interconnected through a Central Gateway (CGW) ECU. The Millimetre Wave Radar, which outputs our target ACC messages is wired on bus 1 which operates at 500 kb/s.

Intercepting the specific ACC messages at the radar CAN lines enables us to alter those acceleration commands based on external inputs from the developed CACC controller and send them towards the CGW ECU. The acceleration command can be requested in the range of -3.5 m/s^2 to 2 m/s^2 with a resolution of 0.001 m/s^2 , which makes it suitable for our application.

3.1.3.3 CACC switch controller

The cruise control switch terminals can be accessed and interfaced with by adjusting the voltage level at the steering wheel assembly. Consequently, control of the ACC switch can be integrated with the controller that manipulates the ACC CAN messages using additional circuitry. This

additional circuit works in parallel with the stock system, allowing the safety driver in the vehicle to take control and operate the switch without having to change anything.

The system developed to control the longitudinal motion of the vehicle via CAN is composed by two hardware components both with two CAN interfaces each, placed in parallel with each other; namely a CAN Msg Manipulator and a CAN Msg Forwarder. The system diagram is shown in the Figure 17, the former is programmed to manipulate the ACC CAN messages from the radar to the CGW ECU and activate the cruise system via general purpose input/output pins from the remote station.

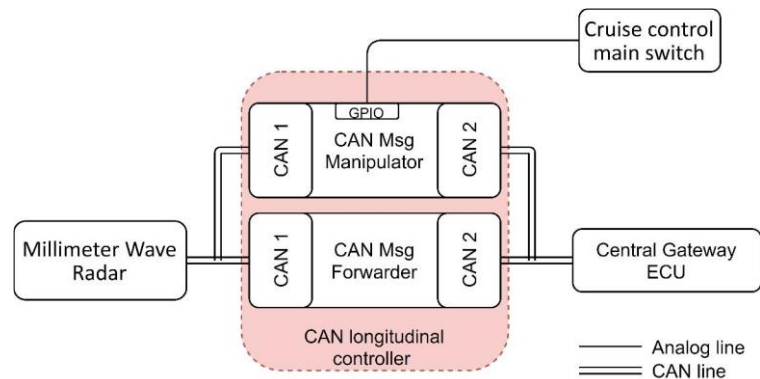

Figure 17 - Longitudinal controller

3.2 Vehicle actuators for teleoperation development

In order to teleoperate the vehicle, the vehicle actuators were modified to enable remote control functionality. In the vehicle side, the throttle pedal and steering wheel are controlled by wire, which means that the respective actuators send electric signals to vehicle's ECU to accelerate or steer. Located between the actuators (pedal and steering wheel), is V-tron's DBW system, which uses Microcontroller Units (MCUs) and coupling in and out circuitry to control the vehicle.

The MCUs operate at 3.3V, therefore, the signals read from the car, 0-5V, need to be adjusted with the functionality of a basic voltage divider. The input signal is scaled down to 3.3V with the coupling in circuits, and the output signal from the MCUs to the vehicle ECUs must be scaled back from 0-3.3V to 0-5V with the coupling out circuits.

3.2.1 Throttle controller

The MCUs are programmed to receive the data commands sent from the station and redirect them to ECU. Data command signals are read from the CAN bus in the DBW system and translated into an analog value using a 12-bit DAC. Therefore, the vehicle behaves according to the driver commands, as if it was being driven directly.

On the other hand, for safety reason the physical pedals are still useful and have priority over the data commands. The throttle pedal uses two Hall sensors with an offset of 1.4V approx. both measuring voltages in the same direction which also detect a magnetic field in the axel of the pedal. These sensors measure voltages in a scale from 0 to 5V depending on the position of the pedal. Therefore, if the throttle pedal is released one sensor measure 0.5 to 1.1 V and the other 2.1 to 3.1 V. In case that the pedal is fully pressed one sensor will measure 3.3 to 4.9 V and the other 4.6 to 5.0 V. For instance, if for any reason the driver in the vehicle needs to take control, physical sensor will obey the instruction over any data coming from the teleoperator. For this scenario, the throttle controller read simultaneously the signal of the actuators with a 10-bit ADC that compare the reading on the HALL sensors. The measured values are bypassed to the DAC which redirect them to the ECU. If these reading are zero, meaning that the car is in standby, therefore the vehicle will obey to the teleoperation commands. However, if the physical signal is different from its idle state, the vehicle neglects the values from the remote station.

3.2.2 Brake controller

The initial concept for controlling the brake pedals was similar to that of the throttle pedal control, utilizing the vehicle CAN bus. However, this method, while effective in initiating brake activation, faced limitations in achieving a full (100%) pedal depression. Since brake pedals are an integral part of the safety systems equipped in the vehicle, the decision to model and install an external actuator was chosen. This solution incorporates a motor and a CAM shaft, as shown in Figure 18, enabling precise actuation of the physical pedals to replicate the movement like an actual driver braking. This approach ensures integration without any necessary for modifications to existing safety systems and they always have precedence. Another huge advantage of this approach is it can be installed in any type of vehicle with minor design modifications.



Figure 18 - Brake actuator

3.2.3 Steering controller

One of the key tasks for remote teleoperation is steering action on the vehicle, where the steering input, in degrees, is sent from the remote station and received by the teleoperation system. When required, the latter relays this steering angle request to the steering controller, which in turn actuates the power steering motor to reach and maintain the desired angle. This is achieved by exploiting the electronic power steering system of the vehicle. The standard power steering system operates by means a torque sensor, it detects a steering effort generated by the driver and converts it to an electrical signal. This signal is processed by the power steering ECU which in turn actuates the power steering motor to assist in turning the steering wheel.

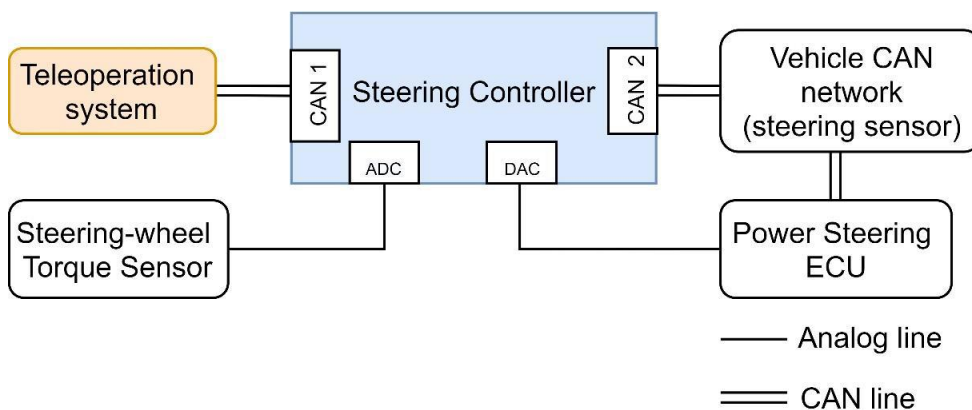

Figure 19 - Steering controller

The steering controller is connected between the torque sensor and the power steering ECU via a 10-bit Analog to Digital Converter (ADC) and Digital to Analog Converter (DAC). This conversion is essential because the microcontrollers can only understand digital values. Subsequently, these signals are converted back into analog signals. Additionally, it is plugged into the CAN bus to extrapolate steering sensor information from the vehicle as well as steering request from the teleoperation system. The steering controller is implemented in the vehicle following the schematic diagram in Figure 19.

The steering controller can maintain both regular operation of the vehicle as well as teleoperation. When no teleoperation is required, the steering controller relays the torque sensor voltage signal received from the ADC to the power steering ECU via the DAC, this ensures that the driver can naturally operate the steering wheel. When teleoperation is requested, the steering controller will stop relaying the voltage signal from the torque sensor and instead, based on the steering request from the teleoperation system, output the necessary voltage via the DAC to reach the desired steering angle. In order to output the required voltage to the ECU a feedback controller is used. The control loop, shown in Figure 20, takes as input the steering angle from the teleoperator via the CAN bus, as feedback the actual steering wheel angle from the vehicle CAN bus and outputs a voltage by means of the DAC. This ensures that as the operator turns the steering wheel on the remote station, the vehicles steering wheel follows the same movements.

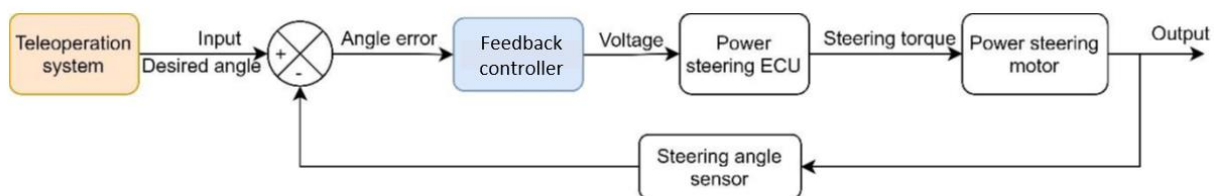

Figure 20 - Control loop

3.3 Remote station integration

For multiple vehicle-controlling modules to be able to issue control commands to the vehicle, there needs to be an integration layer that abstracts the CAN bus communication and acts as an intermediary between the vehicle and the controlling modules. For this purpose, the Roboauto Drive by wire box (RDBW) is used, shown in Figure 21. It is a complete hardware and software system that allows seamless electronic control of a vehicle's brake, throttle, steering, and the control of other peripherals. At the core of the RDBW, the STM32F207 microcontroller is used, which uses the Free RTOS operating system to guarantee accurate task processing timing.



Figure 21 - DBW box

A significant benefit of the RDBW kit is the support of multisource control logic (collision avoidance system, platooning, long-range teleoperation). Ethernet interface is used to connect, control the vehicle, and receive vehicle status

information. The RDBW kit includes automatic priority assurance of the respective control sources and default safety procedures in case of error or extreme values of some control inputs.

3.3.1 Interfacing

To allow multiple modules to communicate with the drive-by-wire kit, it has a (TCP) server running on local port. The control logic then uses the incoming connections to receive control commands and transmit telemetry data. A standardized set of messages is used to communicate between the drive-by-wire box and other modules. Each connection is characterized by its priority, specified by a number ranging from 0 to 6 (a lesser number signifies higher priority). Each priority level can also have a control code assigned, that the incoming connection needs to provide to authorize itself. If a module tries to connect with a priority number that is already used by another module connected to the drive-by-wire box, the old connection will be replaced with the new one. If the module supplies an incorrect control code, the connection is refused. This applies to supplying a non-empty control code when the control code is supposed to be empty.

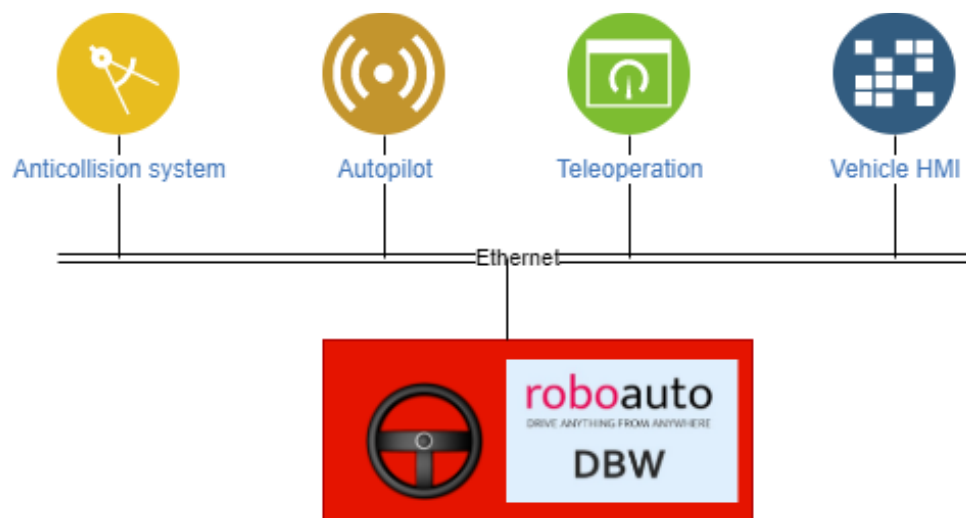

Figure 22 - DBW interfacing

Communication with the RDBW is done through multiple types of messages. They can be divided into two categories:

- The first category is mainly used for communication between the RDBW and controlling modules (or between different controlling modules) and it consists of general communication messages, which include request messages, status messages, error messages, level messages, and log messages. These messages are not configurable and remain the same for each deployment.
- The second category is stream-messages. Stream-messages are used for communication between the controlling modules and the vehicle itself. They include planning control, manual control, odometry, auxiliary control, and other possible types of messages that may be added for the purpose of control of a particular vehicle. These messages depend on the controlled vehicle, and they are configured upon the deployment of RDBW.

3.3.2 Principle

The control logic runs its inner loop with a frequency of 50Hz. In each iteration, the module with the highest priority with a valid control message is selected and assigned a token that allows it to send control messages to the vehicle. Then it distributes the current vehicle and RDBW status to all connected control modules. If the controlling module cannot provide a control message with the frequency of 50Hz (with a tolerance of 5ms), the next connected module with lower priority

that is currently sending valid activated control messages is assigned the ability to control the vehicle. If no module is sending valid activated control messages, the vehicle is stopped. If a module with a higher priority starts sending valid activated control messages, it immediately takes over the control of the vehicle, allowing functionalities like the collision avoidance system to work correctly.

The principle of priorities also allows for flexibility in the form of overriding the controls. For example, normally teleoperation will have a lower priority than a collision avoidance system. However, it may be beneficial for the teleoperator to be able to explicitly elevate the priority of teleoperation for a limited period, and thus manoeuvre the vehicle out of a situation of a potential collision, where it otherwise would be stuck. In that case, a new connection with a higher priority between the teleoperation and the RDBW will be made. After the manoeuvre that requires teleoperation's priority to be elevated is completed, this connection is dropped, and the teleoperation continues to operate with its standard priority.

3.4 Fail safe system

3.4.1 Platooning failure

CACC algorithm is developed and linked on top the teleoperation system hence the operator can always take control. But as a part of the integrated safety system the autonomous emergency braking system and pre collision warning system built into the vehicle were always kept active and can intervene in critical scenarios. Additionally, as a part of the CACC system the heartbeat signal of the network will be constantly monitored in situation where the system detects the loss of V2V connection with the lead vehicle, the system will switch back to the standard ACC system by increasing the following distance and warning the operator. Moreover, the driver or the teleoperator can take control of the vehicle by engaging the brake pedals, where they get the complete control back.

3.4.2 Remote safety button

The integration layer is implemented with a remote stop capability. The purpose of this functionality is for the remote driver, fleet operator, or any other responsible person to be able to immediately stop the vehicle in case of a hazardous situation.

3.4.3 Remote station hardware failure

In case of a hardware failure on the remote station PC, the remote driver may not be able to operate the vehicle anymore. These failures include,

- display hardware failure
- driving input device failure
- other device failures

In these situations, the remote driver needs to be able to immediately react by initiating the stopping procedure on the driven vehicle.

3.4.4 VRU in danger

The ability to remotely stop the teleoperated vehicle is not limited to the remote driver. The fleet manager or on-site supervising officer may also initiate the stop procedure if they deem that a VRU may be in danger.

3.4.5 Implementation

The central stop button registers itself into the gateway, just like the vehicles and remote stations. It can be either assigned to a remote station or function as a standalone entity, e.g., to control multiple vehicles by a safety officer. One button can oversee multiple vehicles, and one vehicle can be controlled by multiple buttons.

Upon connecting a vehicle and a remote station, a stop button is also selected as a part of the session. By default, it is the stop button assigned to the remote station. The operator will not be able to operate the vehicle unless it is connected to the correct stop button. Each stop button has a unique identifier embedded in a certificate and the communication between the stop button and the vehicle is encrypted. For communication, we use the same UDP-based protocol that we use for communication between the remote station and the vehicle, which enables us to have a precise level of control.



Figure 23 - Safety stop implementation

As illustrated in Figure 23, the stop button communicates with a watchdog module that sends an OK signal to the RDBW with a frequency of 100Hz. The watchdog only sends the OK signal if it has received a heartbeat message from the stop button within the last 250ms. The heartbeat messages have a frequency of 50Hz. The watchdog also stops sending the OK signal if a kill signal is received from the stop button. The kill signal mechanism is in place so that it is possible to have a heartbeat timeout large enough to accommodate for latency spikes commonly associated with wireless networks, while also being able to initiate the stopping procedure without further delay of up to the timeout value. When the RDBW ceases to receive the OK signal while in active teleoperation driving mode, a stopping procedure is initiated.

3.4.6 Increased latency constraints

In the case of increased latency, there is not always the need to immediately stop the vehicle if a threshold is not reached. However, worsened conditions must be considered, nevertheless. For this purpose, a mechanism is implemented that allows for limiting the maximum speed the vehicle travels, as well as the maximum level of the throttle. Limiting the throttle means that the vehicle's torque is limited. The throttle (torque) limitation is useful for the cases when the vehicle is not traveling at or near the maximum allowed speed for the given latency, however significant acceleration of the vehicle may be dangerous in worsened latency conditions. The torque is limited indirectly through the level of the throttle, as torque is typically not accessible outside the vehicle's ECU. The latency calculation and the possibility to attach a reaction to the calculated values are embedded in the in-house DTLS-based protocol developed.

In areas with continuously worse conditions an additional adaptive mechanism activates. This mechanism changes stream quality based on current network conditions. The network info state is recorded in pre-set time-window and the correction is automatically performed by the vehicle side as the teleoperator might not be able to react in time or perform required corrections by itself. Essentially it is protection against complete disconnection or bandwidth exhaustion. Stream parameters that can be adjusted are resolution of the frame on the input of the encoder, bitrate of the encoder and the framerate. Additionally, in very poor network conditions, some streams might be disabled completely to save the bandwidth for the primary sensors. Teleoperator then

might be able to drive the vehicle back to the track or area with better network connectivity. There are cases where the teleoperator is allowed to perform the stream quality adjustments manually from the remote station, however the vehicle always has the priority in deciding if the situation requires worse stream quality.

3.5 Network integration

The integration of 5G network technology is a key component of this project. A dedicated 5G router is integrated in the vehicle, enhancing the communication capabilities between the vehicle and the remote station. With the high-speed, low-latency features, seamless communication is established ensuring reliable and responsive operation. The 5G network infrastructure plays a critical role in guaranteeing Quality of Service (QoS), offering a robust framework that prioritizes data transmission efficiency.

Detailed information about the network and its architecture is a part of 'WP 5 – 5G Network' and the comprehensive details are provided in the deliverables from this work package.

4 TEST PLAN

4.1 Testing approach for platooning

The test plan outlines the evaluation of CACC based platooning system implemented in the test vehicles equipped with C-V2X technology. The testing framework focuses on communication and interaction between lead and following vehicles, incorporating advanced sensor technologies and the CACC system to ensure optimal performance in maintaining safe following distances.

4.1.1 Preconditions - CACC

- Safety systems check and V2V communication tests.
- Two Toyota test vehicles, equipped with OBU to facilitate V2V communication of lead vehicle acceleration and speed to the following vehicle via PC5 mode4.
- Lead vehicle acceleration and speed data are obtained through vehicle CAN bus.
- The following vehicle is equipped with an in-vehicle vision sensor to measure the relative speed and the following distance to lead vehicle.
- The following vehicle is equipped with the CACC system with necessary hardware/software, computing the required acceleration to maintain the target following distance.
- Computed acceleration is transmitted through the in-vehicle CAN communication.
- A safety driver is present in the CACC-equipped vehicle to ensure safety throughout testing.
- Tests are conducted at speeds ranging from 40-60 kilometres per hour.
- The minimum road segment must exceed a length of 300 meters to comprehensively assess system performance.
- Testing is performed on isolated roads with no traffic and under acceptable weather conditions.
- Speed, GPS location, and heading information for both vehicles can be shared with partners.
- No input is required from other partners during CACC testing, as all necessary data is obtained from sensors installed by V-tron.

4.1.2 Procedure - CACC

- The lead vehicle will be driven by a driver/teleoperator at low speeds.
- CACC will be activated when the vehicles reach a stable speed.
- The following vehicle equipped with CACC system on-board will follow the lead vehicle with a desired headway time. Test will be conducted for different headway times (starting from 1.4s till 0.8s)
- The CACC system will be mainly tested for 3 conditions:
 - Gap closing: The acceleration of the lead vehicle will be increased gradually, and the behavior of the following vehicle will be monitored. The following vehicle is expected to close the gap created because of the acceleration.
 - Following: The lead vehicle will be driven at a constant speed (zero acceleration), and the behavior of the following vehicle will be monitored. The following vehicle

is expected to follow the current following distance (without large variations)

- Collision avoidance: The lead vehicle will be decelerated (to a complete stop), and the behavior of the following vehicle will be monitored. The following vehicle is expected to react and decelerate instantly and avoid a collision.
- The delay or packet loss in communication will be tested and logged.
- For safety reasons, the driver can deactivate the CACC system at any given time and manually take control of the vehicle (when the communication is lost or during safety critical situations) by just pressing the brake pedal.
- Vehicle ACC takes over (fallback) when there is loss in communication.

4.2 Testing approach for teleoperation

This test plan encompasses the performance evaluation of teleoperation and remote takeover, along with its supporting enabling functions.

4.2.1 Preconditions - Teleoperation

- Network Setup must be completed on both the remote station and vehicle sides.
- Conduct Safety Systems Tests.
- Perform Brake & Throttle Responsiveness Tests.
- Execute Steering Responsiveness Tests.
- Conduct Data Sharing Tests.
- Validate MQTT Server functionality.
- Execute Collision Avoidance tests and optimize as needed.
- Perform Overall Teleoperation Functionality Tests.
- Toyota test vehicle equipped with teleoperation hardware / software.
- Teleoperator input is sent to vehicles through 5G network and the vision feedback from cameras and vehicle data from CAN bus is transmitted back to remote station.
- Tests are conducted on isolated roads with minimal traffic. Safety drivers are always present in the vehicle to take manual control.

4.2.2 Procedure - Teleoperation

- **Safety Systems Test:** This test should be executed with the vehicle travelling at very low speeds (< 5 km/h). In order to avoid any kind of injuries resulting from harsh braking. The test is to be carried out both from the remote station and from inside the vehicle as follows:
 - **From the remote station:** i) the remote station is put in neutral (drive is deactivated); on the vehicle, this should result in: Brake signal fully applied (100%), Throttle is not applied (0%) and steering angle is 0°, ii) the connection between the remote station and the vehicle is lost; on the vehicle, this should result in: Brake signal fully applied (100%), Throttle is not applied (0%) and steering angle is 0°.
 - **Inside the vehicle:** The safety driver presses the manual steering override button; this should immediately give manual steering capabilities to the driver.
- **Steering Responsiveness Test:** Once the connection between the remote station and the vehicle is established, the remote operator turns the steering wheel in the desired

direction; the vehicle's steering wheel should match the requested steering angle with minimal delay. By keeping the remote station steering wheel in a fixed position, the vehicle's steering wheel should keep the requested angle in a stable manner; this should be true of the steering angle transitions as well.

- **Brake Responsiveness Test:** Once the connection between the remote station and the vehicle is established, the remote operator depresses the brake pedal by a certain percentage; the vehicle's braking power should match the requested one with minimal delay. By keeping the remote station brake pedal in a fixed position, the vehicle's brake force should keep the requested percentage in a stable manner. The behavior of the brake pedal should result predictable and natural, unwanted jerking should be minimal.
- **Throttle Responsiveness Test:** Once the connection between the remote station and the vehicle is established, the remote operator depresses the accelerator pedal by a certain percentage; the vehicle's acceleration should match the requested one with minimal delay. By keeping the remote station throttle pedal in a fixed position, the vehicle's acceleration should keep the requested percentage in a stable manner. The behavior of the vehicle's acceleration should result predictable and natural, unwanted jerking should be minimal.
- **Driving Accuracy Test:** In order to evaluate the accuracy and possible delays of the driving experience, the incoming messages to the vehicle will be logged. The physical actuation of the vehicle will be logged as well, and by comparing the output graphs, the delay will be evaluated. A small delay will indicate good accuracy of the actuators and an overall perception of good accuracy.
- **Slow Speed Maneuvering Test:** The vehicle needs to be connected to the remote station, and the previous tests need to have a satisfactory result before carrying this one out. The vehicle will be remotely operated, with the presence of the safety driver, at low speeds. This will simulate a parking maneuver; thus, the steering angles will be large, and the speeds low. The result of this test will further validate the correct functioning of the actuators, their tuning, and the network stability.
- **Regular Speed Maneuvering Test:** The vehicle needs to be connected to the remote station, and the previous tests need to have a satisfactory result before carrying this one out. The vehicle will be remotely operated, with the presence of the safety driver, at higher speeds compared to the previous test. This will simulate an everyday driving experience; thus, the steering angles will be small, and the speeds will be close to the legal limit. The result of this test will further validate the correct functioning of the actuators, their tuning, and the network stability.

4.3 Pilot location

The project's overall storyline, shown in Figure 24, focuses on utilizing 5G network technology to automate and teleoperate specific manoeuvres of the transportation chain, thereby enhancing the efficiency of logistics and transportation, and optimizing the operation. Summarizing the transportation process chain, the containers are shipped globally via inland barges or sea going vessels, then transferred to port facilities. From the ports, they are transported by road to local / regional distribution centres, where they are handled before being supplied to the end user.

The strategic selection of pilot locations adds a dynamic layer to this narrative. The Antwerp and Vlissingen pilots are designed to showcase the streamlined road transportation process between ports/terminals and distribution centres. Meanwhile, the Zelzate pilot serves the crucial role of demonstrating the cross-border scenario, a key element within the project's scope.

The detailed description on pilot sites and the network infrastructure can be found in the deliverables from WP7.

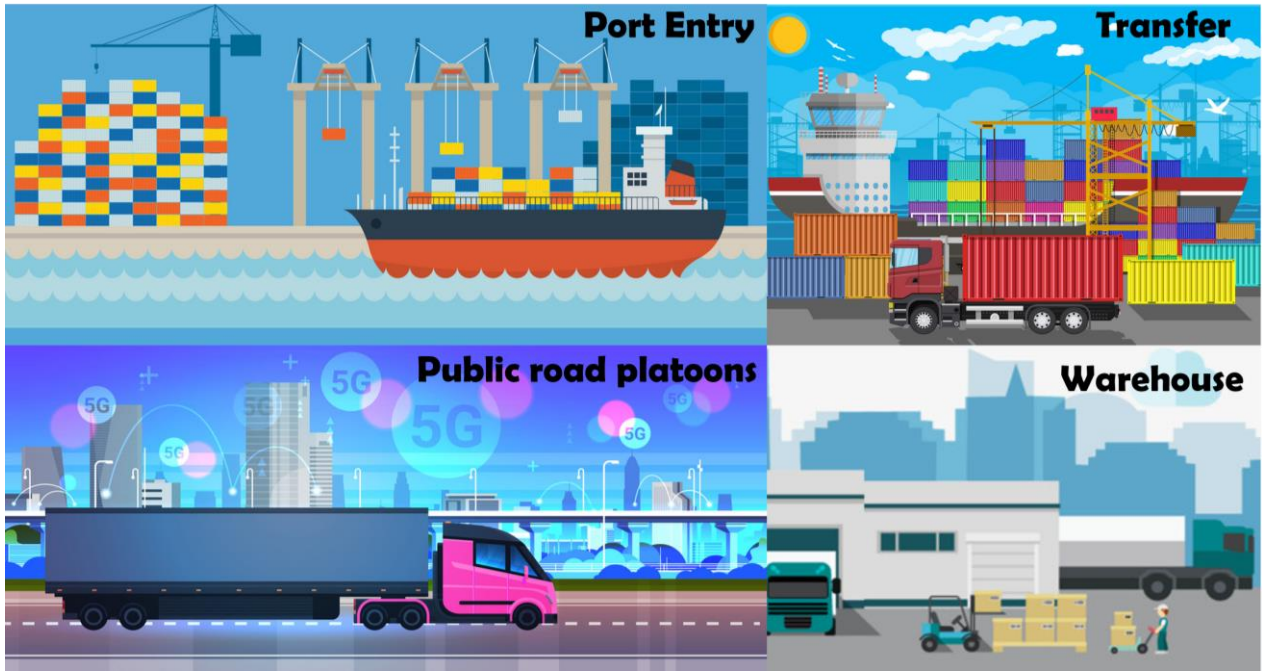

Figure 24 - Overall storyline

Pilot sites	Vlissingen	Antwerp	Zelzate
Teleoperation of cars	Teleoperation of lead vehicle from Verbrugge to MSP onion terminal	Teleoperation from Transport Roosens terminal to MPET terminal	Shadow mode teleoperation crossing border
CACC based platooning	Platooning from Verbrugge to MSP onion terminal	-	-

Table 4: Pilot activities

4.3.1 Vlissingen & Antwerp pilot site

In the Vlissingen site the pilot from the Verbrugge terminal to the MSP onions terminal was performed, which can be seen in Figure 25. In Antwerp pilot site, the route was planned from Transport Roosens to the MPET terminal, as shown in Figure 26.

The Vlissingen pilot site supports 5G networks in both Non-Standalone (NSA) and Standalone (SA) modes. The 5G NSA operates at 700MHz (anchored 1800MHz), and the SA operates at 3.5GHz. In contrast, the Antwerp pilot site consists of two locations with shared commercial infrastructure supporting both 5G NSA and SA. The SA network runs at 3.5GHz, and the NSA network operates at 2.1GHz and 3.5GHz. Both sites utilize four gNodeBs in total.

CACC-based platooning tests were only carried out at the Vlissingen test site. Given the independence of the CACC system from the network infrastructure, the choice of testing location had a minimal significance. The primary focus rested on technology development, and the outcome is expected to remain consistent irrespective of the testing location.



Figure 25: Vlissingen site route



Figure 26 - Antwerp site route

4.3.2 Zelzate cross border site

In Zelzate region, the cross-border functionality of the UC will be deployed. This site is crucial for this UC because of the cross-border situation where the network handover between MNO's will be evaluated. This is a challenging site, as it needs extension to the 5G Core network functionalities of both mobile network operators to facilitate seamless session and service continuity when crossing the border.

The route shown in Figure 28, represents the border crossing between the Netherlands and Belgium where the pilots will be performed.



Figure 27 - Picture taken in Zelzate site

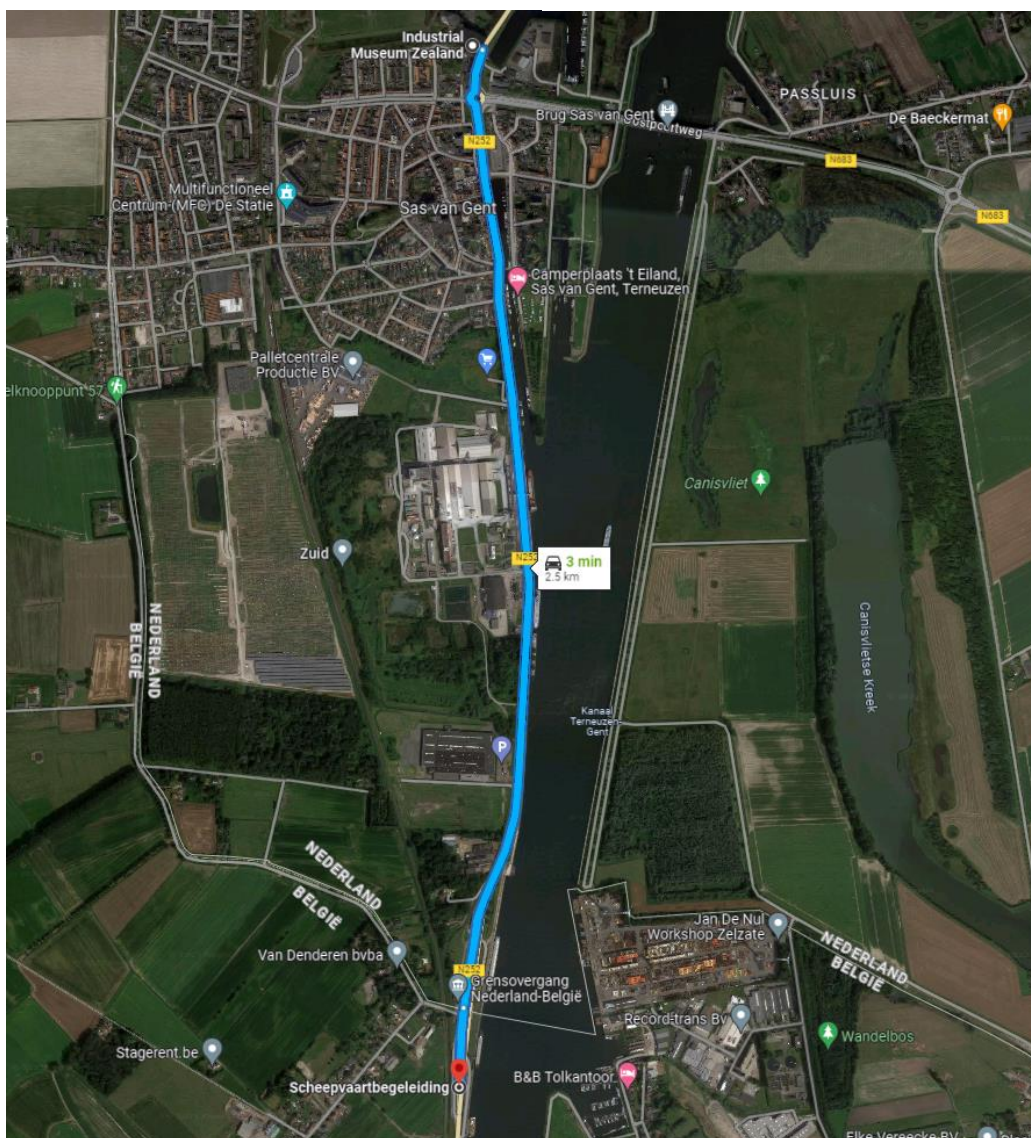

Figure 28: Zelzate cross-border site route

4.4 KPI definition

KPI	Measurement Methodology
CACC	
Following distance (Headway time)	Measured with the vehicle vision sensor in [s]
Distance error	Calculated based on the logged data. Distance is measured in [m]
V2V communication latency	Calculated from the time stamp data measured in [ms]
Packet loss	Calculated based on the total number of packets sent and received
Maximum safe speed achieved	Measured from the vehicle CAN bus
Teleoperation	
Steering accuracy	The steering wheel rotation is measured in degrees [°]
Pedals accuracy	The pedals mapped to a percentage [0-100%]
Maximum safe speed	Maximum possible speed for safe teleoperation in [Kmph]

Table 5: KPI measurement methodology

KPI	Status	Reasoning
Packet loss	Added	The packet loss is a key factor for defining the robustness of the communication. This is crucial for such a system as large packet losses would lead to disengagement of CACC system.
Maximum acceleration / deceleration	Removed	From the previous results it was noted that the controller and the vehicle always stay within the maximum acceleration/deceleration rate, also due to the physical limitations of vehicle actuation. It is therefore decided as unnecessary for KPI measurement.
Number of human interventions	Removed	From the tests conducted, it was noted that there is no need for human interventions during the closed environment testing scenario. This is more applicable if the tests were performed in real dynamic traffic.
Network related KPIs for teleoperation	Removed	The network related KPIs are more significant for WP5, therefore included in the KPIs from WP5
Teleoperation Overridability	Removed	From different tests it was clear that this KPI was not characterizing any aspect of the system.

Table 6: Modifications in KPIs

5 RESULTS & DISCUSSION

5.1 CACC test results

The results of the CACC test conducted in the Vlissingen pilot site are presented in this section. The tests were performed in daytime with clear weather and minimal traffic. Safety drivers were present in both the following and lead vehicles to take manual control whenever necessary and dedicated safety personnel were included to provide a safe testing environment. The point of interest was to monitor the following vehicle's behavior during acceleration, steady speed following and deceleration. The results obtained were consistent with benchmarking test results, which validates the robustness of the overall system. The benchmarking test results are added in Appendix C.

5.1.1 Headway time:

During the maneuver, the following vehicle is set to follow the lead vehicle with a 0.8 second headway time. From Figure 29, it can be seen that the following vehicle's velocity matches closely with the lead vehicle's velocity. The controller is able to control the following vehicle with the set headway time with minimal distance error throughout the maneuver and was able to bring the vehicle to a complete stop at the end of the maneuver.

5.1.2 Distance error:

The distance error was close to zero during the steady state driving and an overall mean error was within 2 – 4 %. Analyzing the standard deviation and 95th percentile values, the results are close to the target values, thereby validating the overall performance of the CACC system. The distance error had a standard deviation of 0.5 which proves that the error deviation is very small and 95th percentile of 1.26. The CACC is a dynamic system, and the error values are expected to be higher during the transition phase when the speed is changing and stabilize during the steady state driving. This explains the comparatively bigger 95th percentile value.

5.1.3 Maximum speed achieved:

During the test, the lead vehicle was driven by the safety driver and the maximum speed was limited to 60 Kmph (speed limit of the test route). The speed profile was selected to validate the point of interest. The test starts at around 45 Kmph and the lead vehicle accelerates till it reaches 60 Kmph. After driving at a constant speed, the lead vehicle decelerates back to 45Kmph before it comes to a complete stop. (The system has been tested for higher speeds till 100 kmph and provides similar results)

5.1.4 Communication latency and packet loss:

The V2V performance is shown in Figure 30. It can be seen that the latency values are around 18 ms which is consistent with the defined KPI. The standard deviation and the 95th percentile values are analyzed and are close to the target values. The latency has a standard deviation of 2.53 and the 95th percentile was 22 which is close to the mean value, validating the consistent performance of the communication.

The total number of messages sent and received is logged to compute the packet losses. Communication had 2 % packet losses and was an improvement on the benchmarking test, which could be because of the less disturbance from the surrounding. The previous tests were performed in moderate to high traffic, whereas these tests were performed with minimal to no traffic.

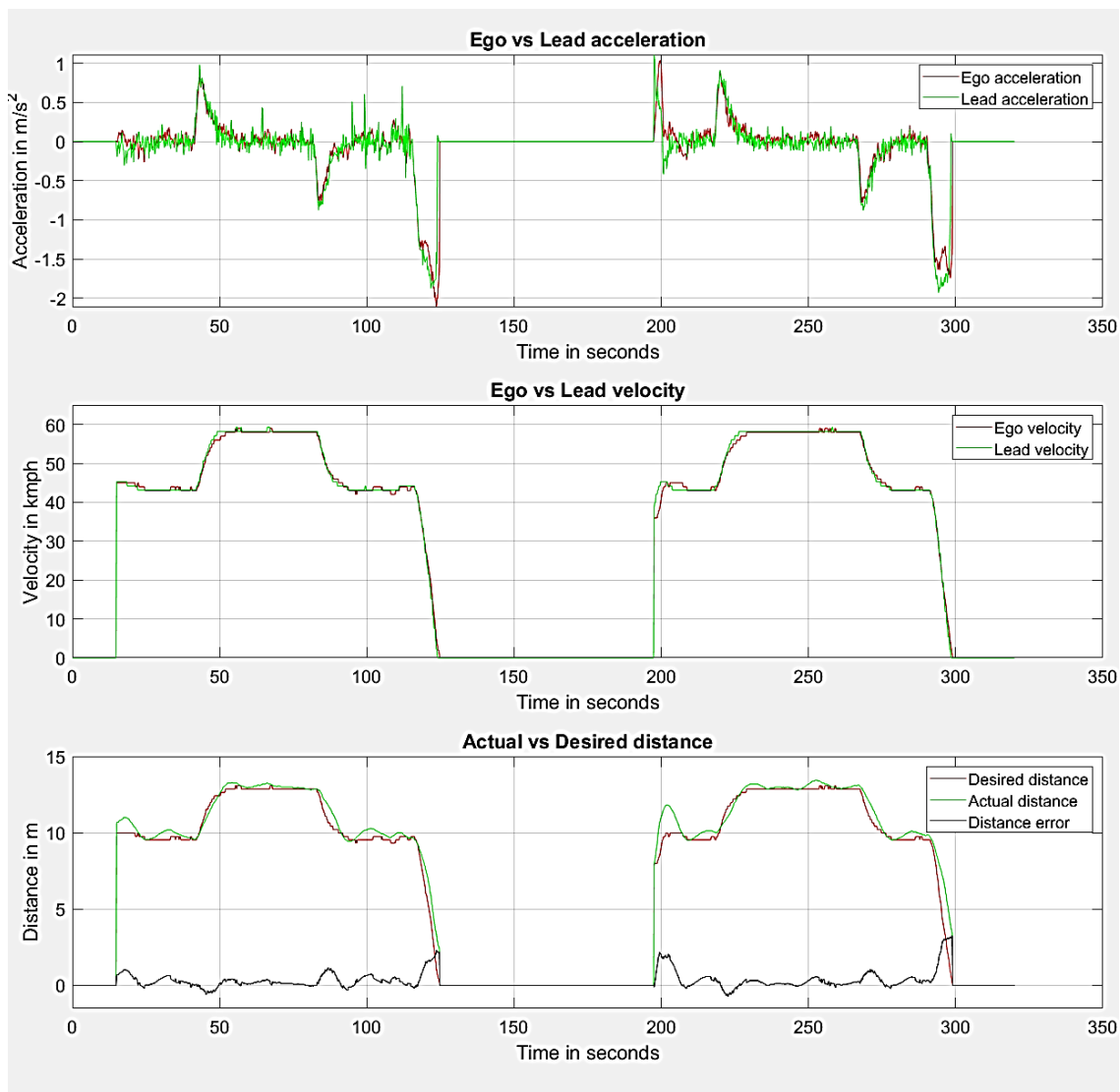

Figure 29 – CACC test results

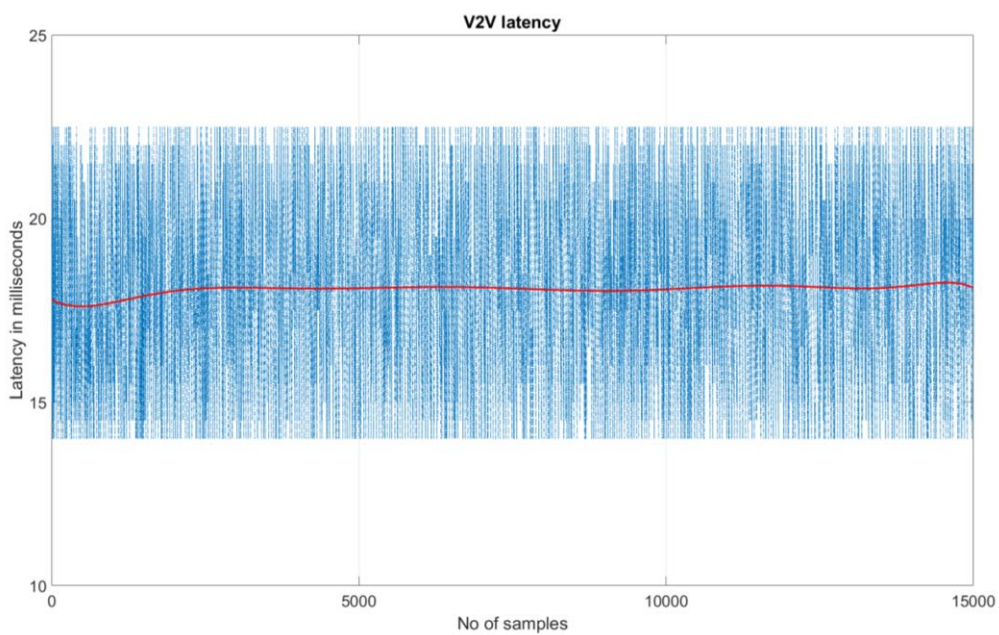

Figure 30 - V2V latency plot

KPI	Definition	Target values	Measurement
Following distance (Headway time)	The minimum achievable headway to the lead vehicle	1 [s]	0.8 [s]
Distance error	Difference between actual and desired distance	Less than 5% (in steady state condition)	2 - 4 % (Mean error – 0.25 m)
Latency - V2V communication	Delay communicating the message from lead vehicle	20 [ms]	18 [ms] (Average)
Packet loss	The number of packets lost in the V2V communication	Less than 5% (within 100 m distance)	2 %
Maximum test speed	Maximum achievable speed with CACC activated	60 [Kmph] (Limited for testing purpose)	60 [Kmph]

Table 7: CACC KPIs measured in Vlissingen pilot site

KPI	Std. Deviation	95 th Percentile
Following distance (Headway time)	0.3981	0.9009
Distance error	0.5176	1.263
V2V communication latency	2.529	22
Packet loss	-	-
Maximum safe speed achieved	-	-

Table 8: CACC KPIs Statistical values

5.2 Teleoperation test results

The graphs in Figure 31 show the comparison between the behaviour of the vehicle as requested by the remote operator and the one accomplished by the vehicle from Antwerp testing. This was done to show relevant data regarding the reactivity of the system with respect to steering angle and pedal position. The Vlissingen testing also provided comparable results. It can be seen how the graphs in Figure 32 are very closely related with minimal errors.

5.2.1 Steering accuracy

When analysing the steering angle graphs, it is evident that there is a close correlation between them, with only minor errors. Specifically, the comparison between the requested steering angle and the vehicle's steering angle shows a Mean Absolute Error (MAE) of 4.56 degrees. While this value slightly exceeds the desired value, it is still within an acceptable range, given that the 90th percentile for steering is 6.877 degrees. Moreover, the sample size of 3001 further reinforces the validity of the results. Additionally, the standard deviation of 6.29 degrees highlights the system's ability to maintain a consistent level of accuracy, with most of the data points falling within an acceptable range of deviation from the requested steering angle. The weather conditions have very minimal impact on the results. It is important to note that there is an inherent error factor in the system, which cannot be eliminated due to physical actuation limitations. Nonetheless, the system's overall performance remains acceptable.

5.2.2 Pedals accuracy

Regarding the throttle pedal results, they are within expectation. This can be attributed to a standard deviation of 1.17% and a 90th percentile of 2.041. This is due to the fact that there is no physical actuation of the pedal, resulting in faster response. It is to be noted that, for Antwerp tests, only the throttle pedal has been shown, this is due to the fact that the brake pedal has a different unit output from the vehicle, which does not allow for direct comparison. This was rectified and presented in the Vlissingen tests.

The MAE for brake pedal positions were 0.51 indicating that it was within the acceptable range. Although the brake pedal results were better, the throttle accuracy KPIs were still satisfactory. Comparing the results, the brake pedal showed greater similarity between teleoperation and the car.

5.2.3 Maximum safe speed

During the period of 30 seconds, the speed of the vehicle varies between 8 and 13 km/h. This limitation was in place due to the fact that the testing perimeter was not sufficiently large to drive at faster speeds during these manoeuvres. The maximum safe speed indicator is based on the experience of the remote operator. It was shown that driving at 30 km/h still gave the remote operator a feeling of comfortability while driving.

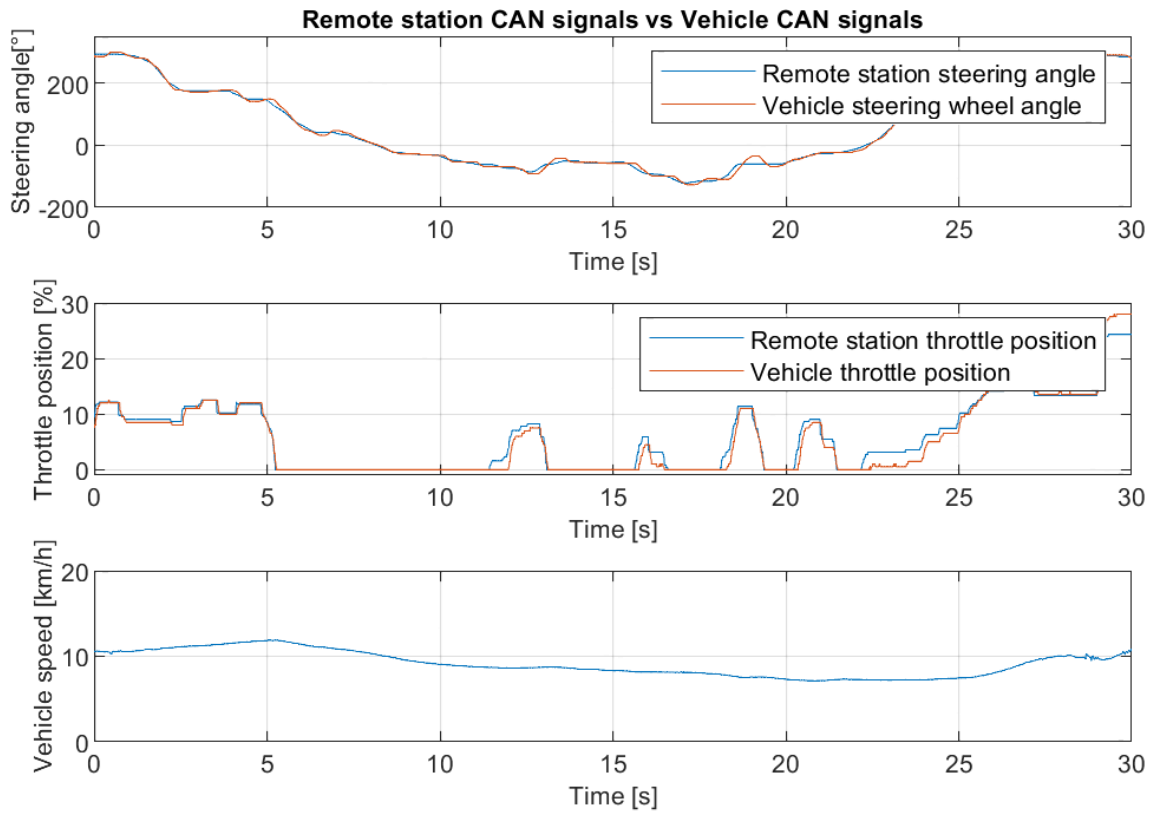

Figure 31 - Antwerp test results

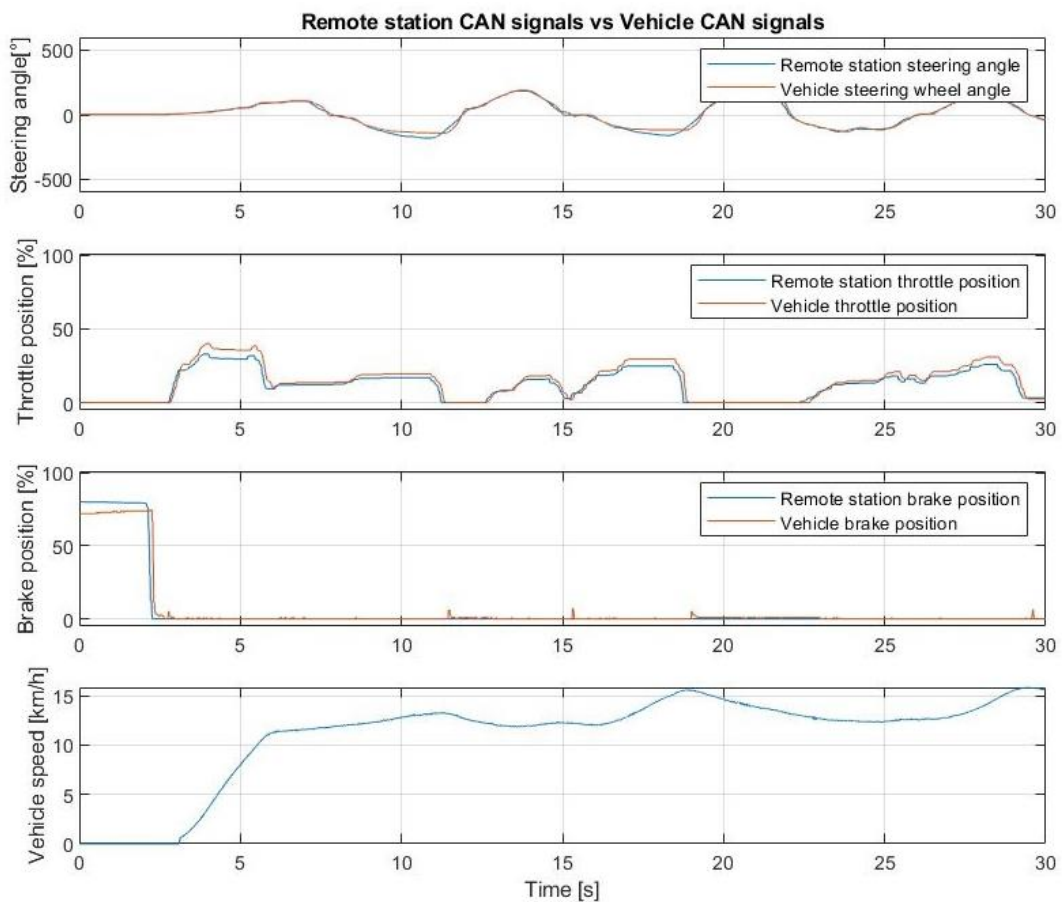

Figure 32 - Vlissingen test results

KPI	Definition	Target values	Measurement	
			Vlissingen	Antwerp
Steering accuracy	The input given through the driving station should be the same on the teleoperated vehicle.	Mean error < 0.1 [°] Mean Absolute Error (MAE) < 3.0 [°] Root Mean Squared Error (RMSE) < 5.0 [°]	Mean error = 0.11 [°] MAE = 2.41 [°] RMSE = 3.85 [°]	Mean error = 0.077 [°] MAE = 4.56 [°] RMSE = 6.29 [°]
Brake / Throttle Pedals accuracy	The input given through the driving station should be the same on the teleoperated vehicle.	Mean error < 1.0 [%] Mean Absolute Error (MAE) < 4.0 [%] Root Mean Squared Error (RMSE) < 6.0 [%]	Mean error = 0.33 [%] / 0.88 [%] MAE = 0.51 [%] / 1.27 [%] RMSE = 1.08 [%], 2.09 [%]	Mean error = 0.32 [%] MAE = 0.702 [%] RMSE = 1.22 [%]
Maximum safe speed	Maximum possible speed for safe teleoperation.	25 [Kmph]	Limited to 15Kmph	>30Kmph

Table 9: Teleoperation KPIs

KPI	Vlissingen		Antwerp	
	Std. Deviation	95 th Percentile	Std. Deviation	90 th Percentile
Steering accuracy	3.85 [°]	5.75	6.29 [°]	6.877
Brake/ Throttle pedal accuracy	1.04 / 1.91 [°]	2.41 / 1.17	1.17[°]	2.041
Maximum safe speed	-	-	-	-

Table 10: Teleoperation KPIs Statistical values

5.3 Zelzate test results

The Zelzate cross-border pilot serves as an important demonstration of the proposed use case. Beyond assessing the technical capabilities of the system, particular emphasis is placed on validating network handover for this scenario. The testing involves teleoperating cars from the Netherlands to Belgium and back. The KPN network tower in the Netherlands and the Telenet network tower in Belgium are placed strategically to realize this handover scenario. The crucial parameter evaluated here is the network handover latency.

Given the public road nature of the test environment, teleoperation was executed in shadow mode for safety reasons. Analysis of the results indicates an impressive network latency of approximately 120 milliseconds, which is a low value. Importantly, the results suggest that this minimal latency does not impede teleoperation, validating the seamless ability of teleoperators to navigate cross-border situations. This result constitutes a strong validation of the use case's performance in real-world scenarios.

The identical scenario was tested using a 4G network, resulting in a handover latency that exceeded the acceptable threshold. Consequently, both the vehicle and the remote station consistently experienced disconnections, making seamless teleoperation in cross-border scenarios unattainable with a 4G network. This highlights the necessity of 5G network to meet the operational demands of such a system.

5.4 V2V vs V2N testing

To further evaluate the CACC based platooning system, additional tests were conducted, implementing Vehicle-to-Network (V2N) technology. Additionally, the data exchange broker was set up at the edge of the network in order to have minimal latency. The objective was to compare and benchmark the results obtained through V2V communication with those achieved using V2N in a platooning scenario. The experiment aimed to assess the performance differences between the two communication approaches and gain insights into their applicability for such a system.

The platooning system was tested in a controlled environment, with the presence of a network tower close by, enabling V2N communication. The testing procedure (total testing distance, speed, target headway time) was kept similar for both V2V and V2N scenarios to have a comprehensive analysis and to quantify the results.

Analyzing the results, shown in Figure 33 and Figure 34, under the specific conditions of the test environment, there was not a substantial difference in performance. However, it is crucial to acknowledge that this outcome is largely attributed to the proximity of the network tower to the testing area. In a global deployment scenario where network towers may not always be situated nearby, the performance of V2N is likely to experience a reduction in performance compared to the more robust and efficient short-range V2V communication.

Therefore, the choice between V2V and V2N for platooning should be made with consideration of the deployment context. Short-range V2V communication is the preferred option, with its advantages in speed, robustness, and efficiency, especially in scenarios where long-range V2N communication may not be consistent.

KPI	V2V data	V2N data
	Measured values	Measured values
Following distance (Headway time)	0.8 s	0.8 s
Distance error	<4%	<4%
Communication latency	18 ms	60 ms
Packet loss	2%	-
Maximum safe speed achieved	100 Kmph	100 Kmph

Table 11: Comparison between V2V and V2N results

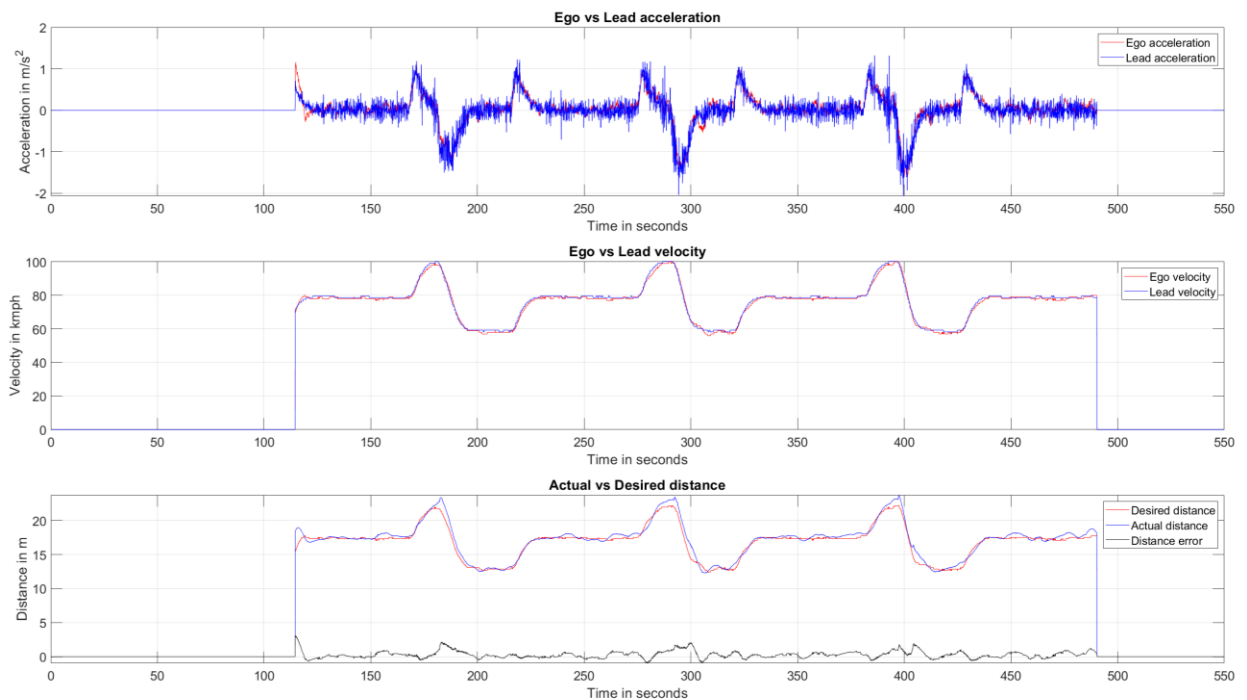

Figure 33 - V2V results

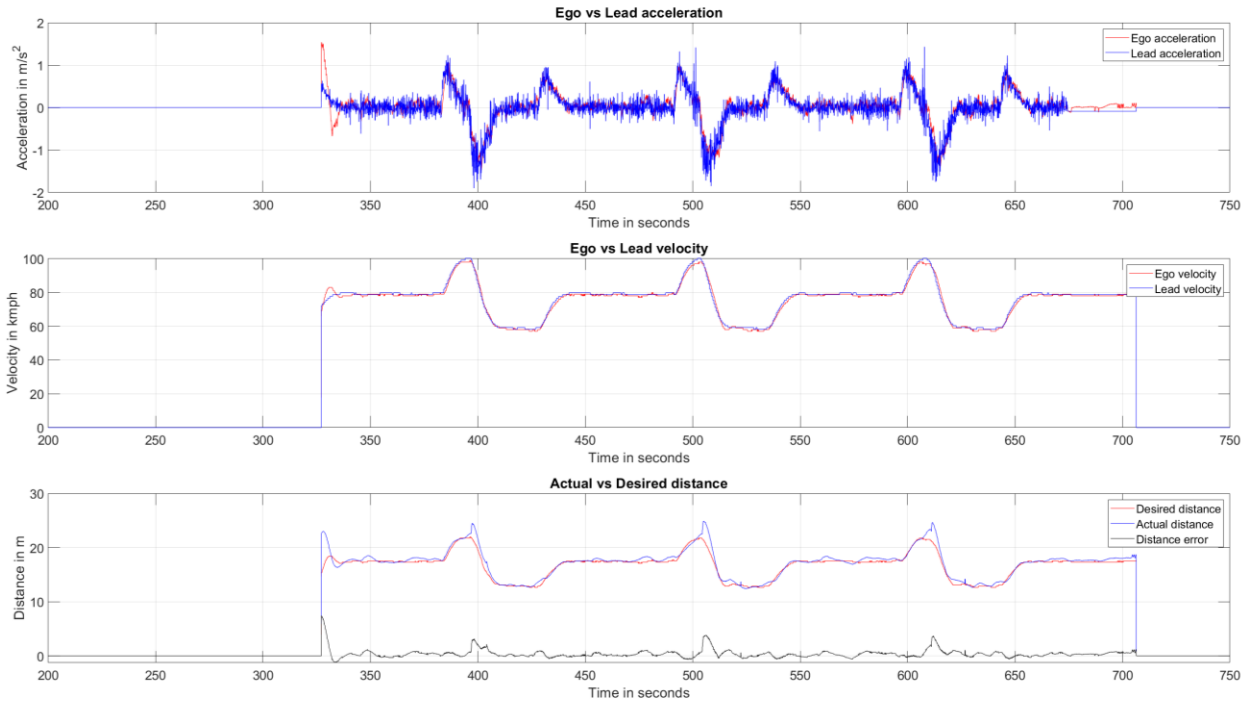

Figure 34 - V2N results

6 CONCLUSIONS

The use case demonstrates a comprehensive assessment of 5G network technology with teleoperated platooning. The development emphasizes the potential of 5G communication in enabling seamless vehicle communication, evaluating the real-world performance of teleoperation, and platooning across diverse traffic conditions. The integration of hybrid communication is highlighted as crucial for maintaining harmonious platooning. Additionally, the use case explores teleoperation features through a robust 5G network connection, extending its scope to cross-border operations, with the adaptability of these technologies on an international scale.

The teleoperation-based platooning system features teleoperation of the lead vehicle by a teleoperator, while the subsequent vehicle autonomously following the lead vehicle, forming a platoon, with the possibility to take over remotely. The in-vehicle hardware setup, comprising on-board computers and a dedicated C-V2X box, facilitates seamless communication and control within the vehicle. For teleoperation, the hardware setup enables remote vehicle control, with the 5G routers and antennas facilitating long-range communication with the remote station, ensuring robust connectivity.

The project's overall storyline justifies the selection of pilot locations for testing. The Antwerp and Vlissingen pilots demonstrates streamlined road transportation processes, while the Zelzate pilot showcases the cross-border scenario. The comparative analysis of vehicle behaviour based on the remote operator request demonstrated a close correlation in actuation accuracy. Despite minor deviations, the system consistently demonstrated acceptable performance, ensuring a safe and reliable environment for teleoperation. The Zelzate site was crucial for testing the cross-border functionality of the use case, evaluating network handovers between mobile network operators. The successful achievement of network handover latency of 120 milliseconds made it possible to teleoperate the vehicles across borders seamlessly. The findings and technological advancements achieved in these pilots contribute valuable insights for the future development and implementation of efficient and automated transportation systems.

The CACC test demonstrated robust performance in acceleration, steady speed following, and deceleration. The headway time of 0.8 seconds was effectively maintained, and the distance error during steady-state driving was within 2-4%. The communication latency, averaging around 18 ms with 2% packet loss, aligned with defined KPIs, validating consistent system performance. In addition to achieving the defined objectives, the use case also explored the possibility of V2N technology for platooning application. The findings highlight the importance of contextual deployment considerations when choosing between V2V and V2N communication. While results indicate comparable performance under specific test conditions, the emphasis on the efficiency and robustness of V2V communication remained consistent, especially in scenarios where V2N communication can encounter challenges.

In conclusion, the 5G-Blueprint project stands as an advancement, not only in the automotive industry but in the broader landscape of technological innovation. The successful integration of 5G technology signifies more than just a leap in efficiency, as it signifies a new era of collaboration and efficiency for the future of automotive technology within transport and logistics sector. The successful demonstration of the use case not only serves as a benchmark for future projects but also lays the groundwork for their implementation.

Transforming this conceptual success into a tangible reality will require dedicated time, effort, and most importantly it will require a joint development from different industries including network operators, transport and logistics partners, automotive industry, and government bodies.

APPENDIX A – PROCESS FLOW

The flow diagram below outlines the process of the use case operation.

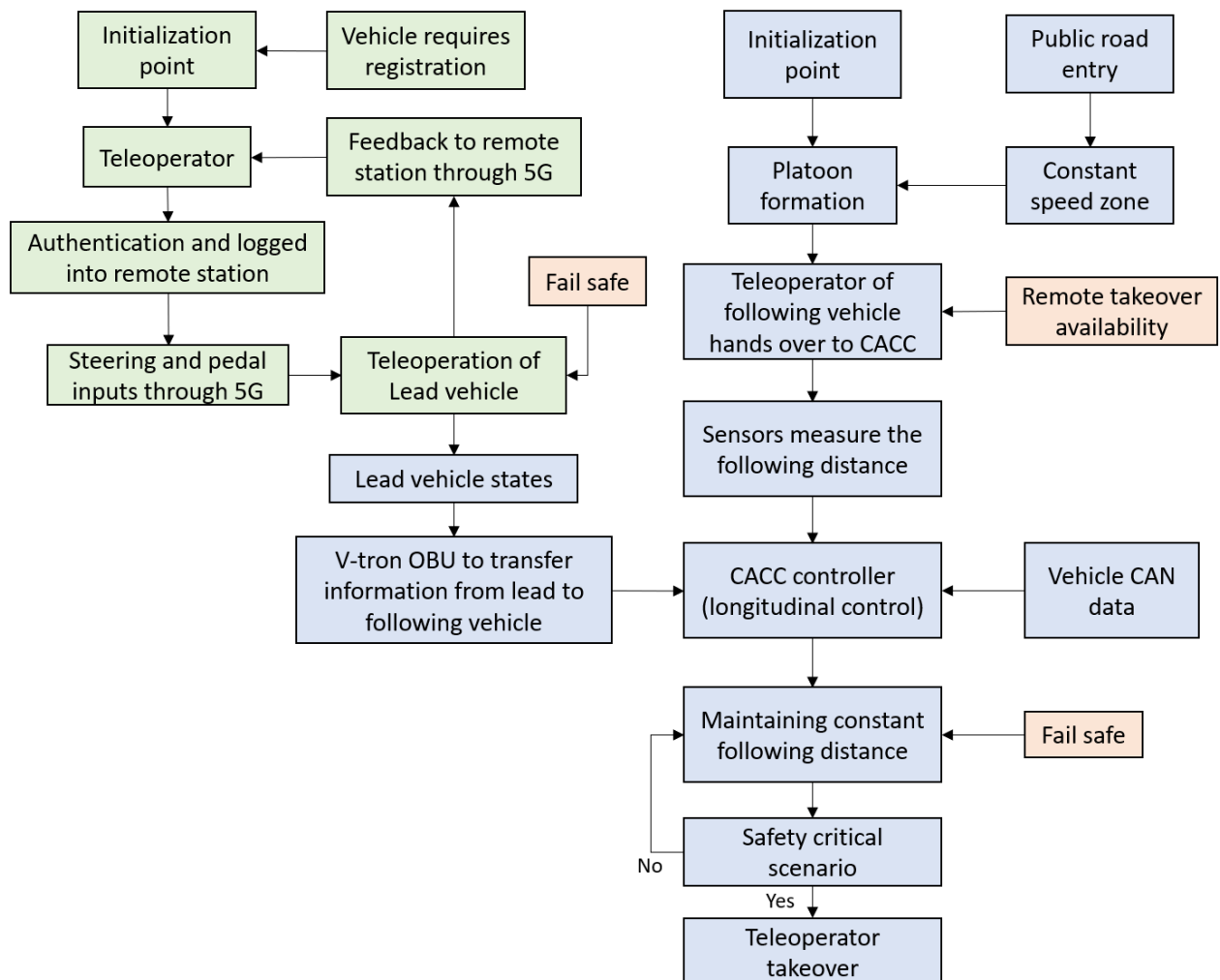

APPENDIX B – VEHICLE POV

The images displayed below are captured by the teleoperation cameras, providing the vehicle's point of view. This is the visual perspective displayed to the teleoperator in the remote station. Furthermore, the overlay of feedback showing the vehicle speed and network strength can be seen in the image below.



Front & rear view



Left side view



Right side view

APPENDIX C – CACC BENCHMARKING

During the initial phase of testing, the primary objective is to benchmark the CACC system against the standard ACC system. The objective of this testing was to compare the performance of CACC with two communication technologies, WiFi-P (ITS-G5 communication) and C-V2X (PC5 mode4).

The experiments were conducted in a controlled environment, featuring the lead vehicle initially driving at approximately 45 Kmph, increasing to 60 Kmph, and then returning to 45 Kmph before coming to a complete stop. In each case, the following vehicle successfully followed the lead vehicle, and the performance differences are graphically shown in the plots below.

The comparison between the stock ACC and CACC systems emphasizes that the developed CACC system exhibits characteristics similar to ACC but with a smaller headway time, allowing for closer following. Notably, the overall reaction time of the CACC system is enhanced due to continuous communication of the lead vehicle's current state to the following vehicle, as opposed to ACC, which relies on sensor measurements.

This testing phase is carried out as a benchmarking exercise, for further evaluation and optimization of the CACC system. Additionally, the comparison between WiFi-P and C-V2X communication technologies provides insights into their respective performances in the context of CACC, paving the way for informed decisions in the system's future development. The activation and basic functioning of CACC is kept similar to the stock ACC system, prioritizing simplicity and safe operation.

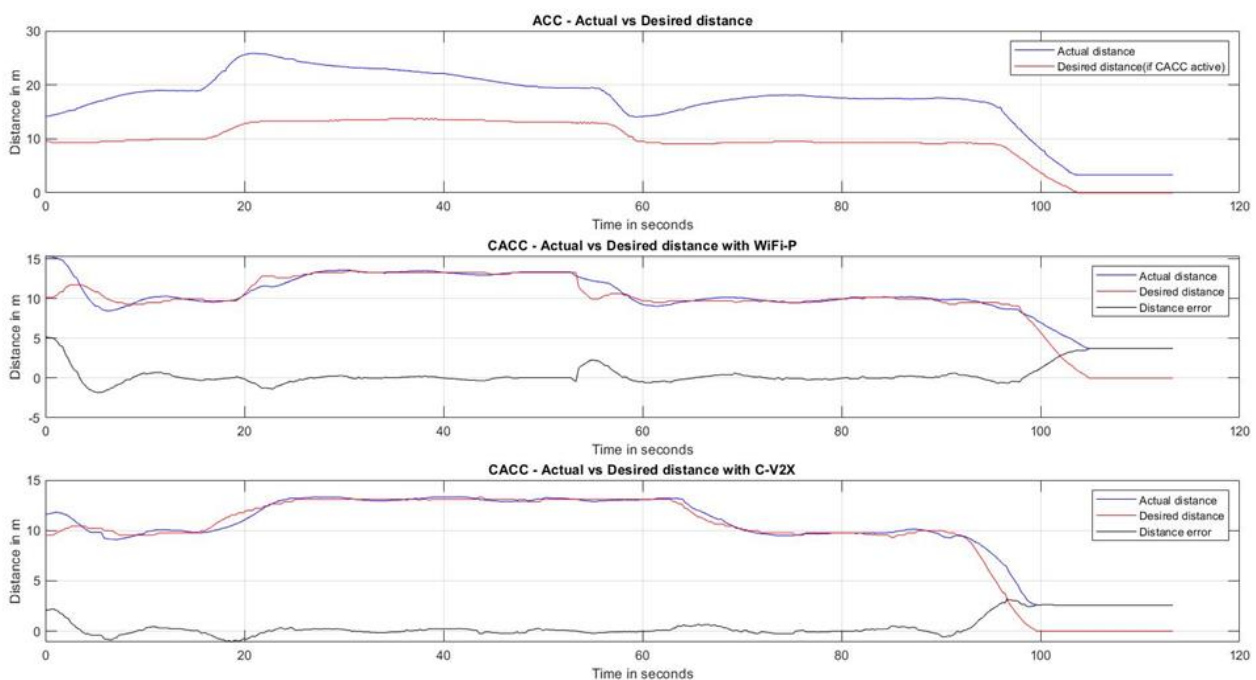

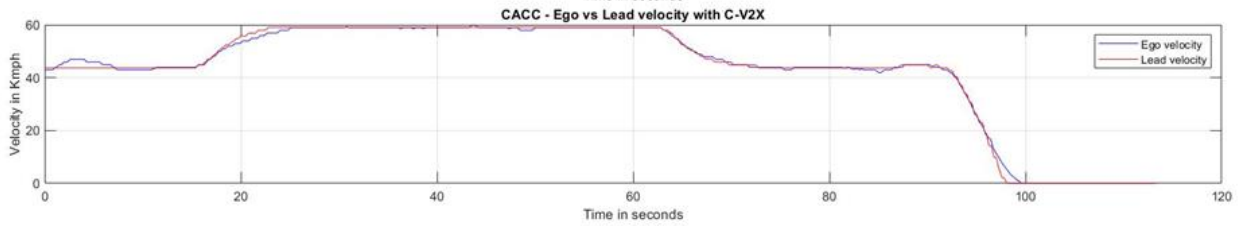
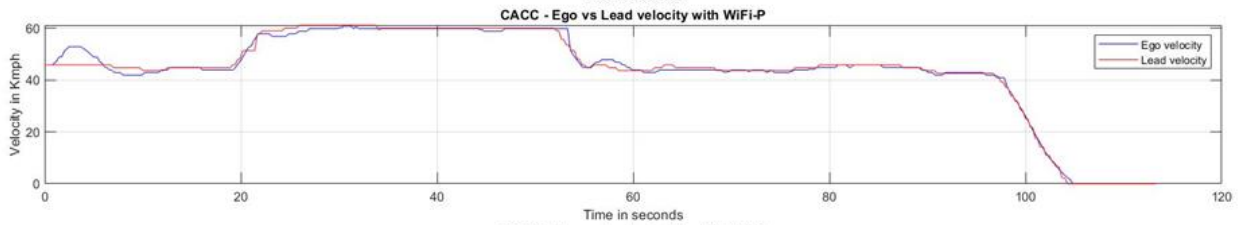
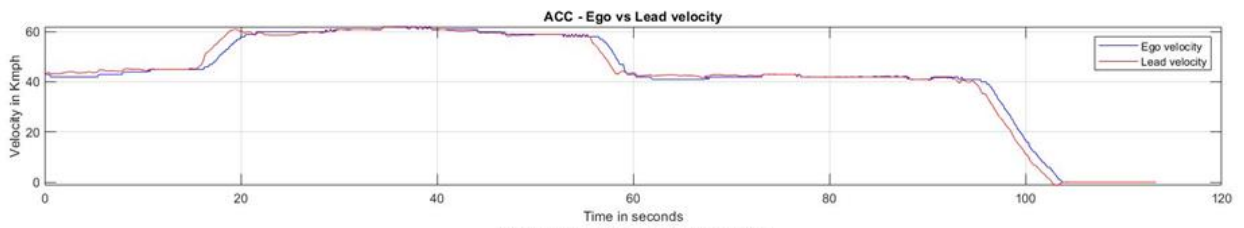
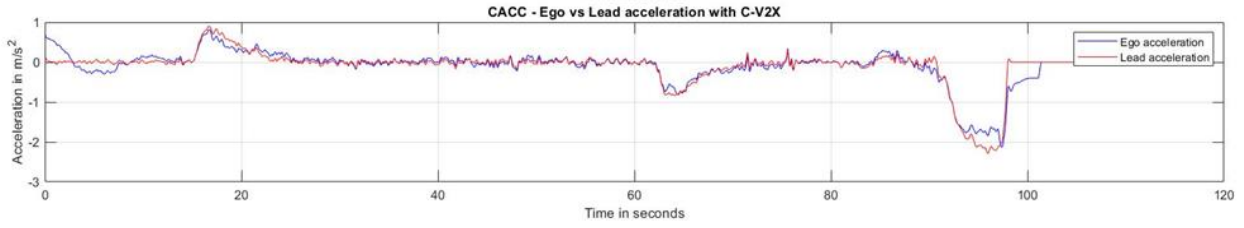
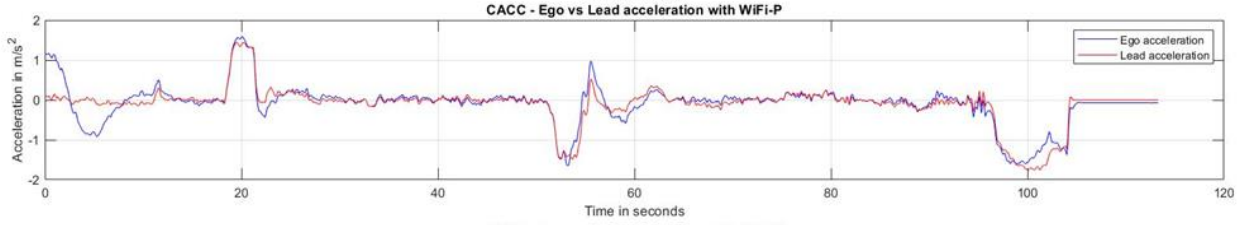
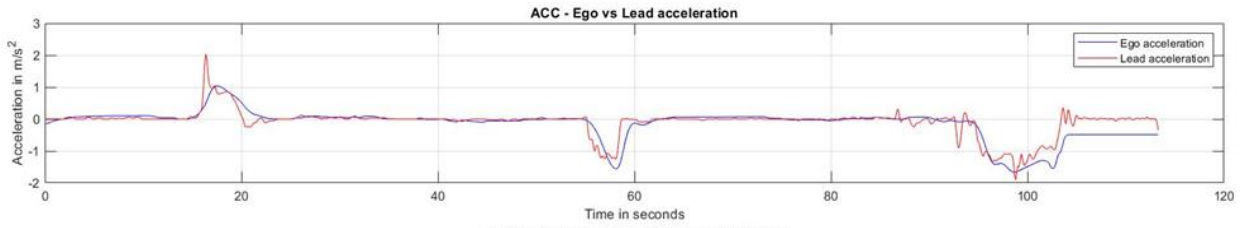

REFERENCES

- [1] J. Ploeg, B. T. Scheepers, E. Van Nunen, N. Van De Wouw, and H. Nijmeijer, "Design and experimental evaluation of cooperative adaptive cruise control," in IEEE Conference on Intelligent Transportation Systems, Proceedings, ITSC, 2011, pp. 260–265.
- [2] V. Milanés, S. E. Shladover, J. Spring, C. Nowakowski, H. Kawazoe, and M. Nakamura, "Cooperative adaptive cruise control in real traffic situations," IEEE Transactions on Intelligent Transportation Systems, vol. 15, no. 1, pp. 296–305, 2014.
- [3] Y. Zhang, Y. Bai, J. Hu, and M. Wang, "Control Design, Stability Analysis, and Traffic Flow Implications for Cooperative Adaptive Cruise Control Systems with Compensation of Communication Delay," Transportation Research Record: Journal of the Transportation Research Board, no. March 2020.
- [4] S. Gong, A. Zhou, J. Wang, T. Li, and S. Peeta, "Cooperative Adaptive Cruise Control for a Platoon of Connected and Autonomous Vehicles Considering Dynamic Information Flow Topology. (arXiv:1807.02224v2 [cs.SY] UPDATED)," Center for Connected Automated Transportation, 2018.
- [5] E. Semsar-Kazerooni, K. Elferink, J. Ploeg, and H. Nijmeijer, "Multi-objective platoon maneuvering using artificial potential fields," IFAC (International Federation of Automatic Control), vol. 50, no. 1, pp. 15 006–15 011, 2017. [Online]. Available: <https://doi.org/10.1016/j.ifacol.2017.08.2570>
- [6] E. Van Nunen, J. Verhaegh, E. Silvas, E. Semsar-Kazerooni, and N. Van De Wouw, "Robust model predictive cooperative adaptive cruise control subject to V2V impairments," in IEEE Conference on Intelligent Transportation Systems, Proceedings, 2017, pp. 1063 – 1071.
- [7] R. Molina-masegosa and J. Gozálvez, "A New 5G Technology for Short-Range Vehicle-to-Everything Communications," IEEE vehicular technology magazine, no. December 2017, pp. 30–39, 2017.
- [8] C. Lei, E. M. Van Eenennaam, W. K. Wolterink, G. Karagiannis, G. Heijenk, and J. Ploeg, "Impact of packet loss on CACC string stability performance," in 2011 11th International Conference on ITS Telecommunications, ITST 2011. IEEE, 2011, pp. 381–386.
- [9] E. Semsar-Kazerooni, J. Verhaegh, J. Ploeg, and M. Alirezaei, "Cooperative adaptive cruise control: An artificial potential field approach," in IEEE Intelligent Vehicles Symposium, Proceedings, vol. 2016-Augus, no. IV. IEEE, 2016, pp. 361–367.